

# **Chapter 4**

## **Optical Sources**

# Contents

- Review of Semiconductor Physics
- Light Emitting Diode (LED)
  - Structure, Material, Quantum efficiency, LED Power, Modulation
- Laser Diodes
  - structure, Modes, Rate Equation, Quantum efficiency, Resonant frequencies, Radiation pattern
- Single-Mode Lasers
  - DFB (Distributed-FeedBack) laser, Distributed-Bragg Reflector, Modulation
- Light-source Linearity
- Noise in Lasers

# Considerations with Optical Sources

- Physical dimensions to suit the fiber
- Narrow radiation pattern (beam width)
- Linearity (output light power proportional to driving current)
- Ability to be directly modulated by varying driving current
- Fast response time (wide band)
- Adequate output power into the fiber

# Considerations...

- Narrow spectral width (or line width)
- Stability and efficiency
- Driving circuit issues
- Reliability and cost

# Semiconductor Light Sources

- A **PN** junction (that consists of direct band gap semiconductor materials) acts as the *active* or *recombination* region.
- When the PN junction is forward biased, electrons and holes recombine either *radiatively* (emitting photons) or *non-radiatively* (emitting heat). This is simple LED operation.
- In a LASER, the photon is further processed in a resonance cavity to achieve a *coherent, highly directional* optical beam with *narrow linewidth*.

# LED vs. laser spectral width

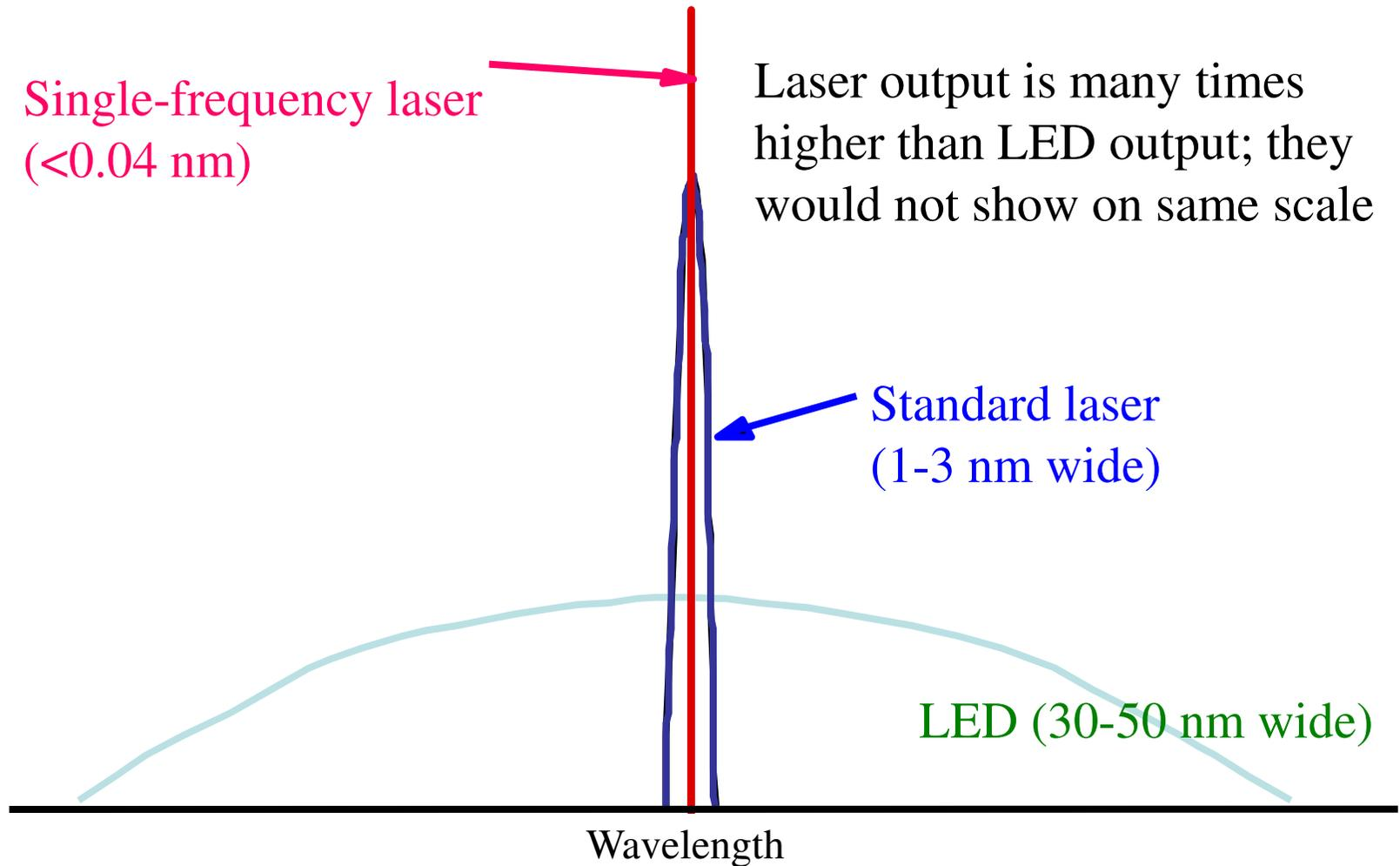

# Review of Semiconductor Physics

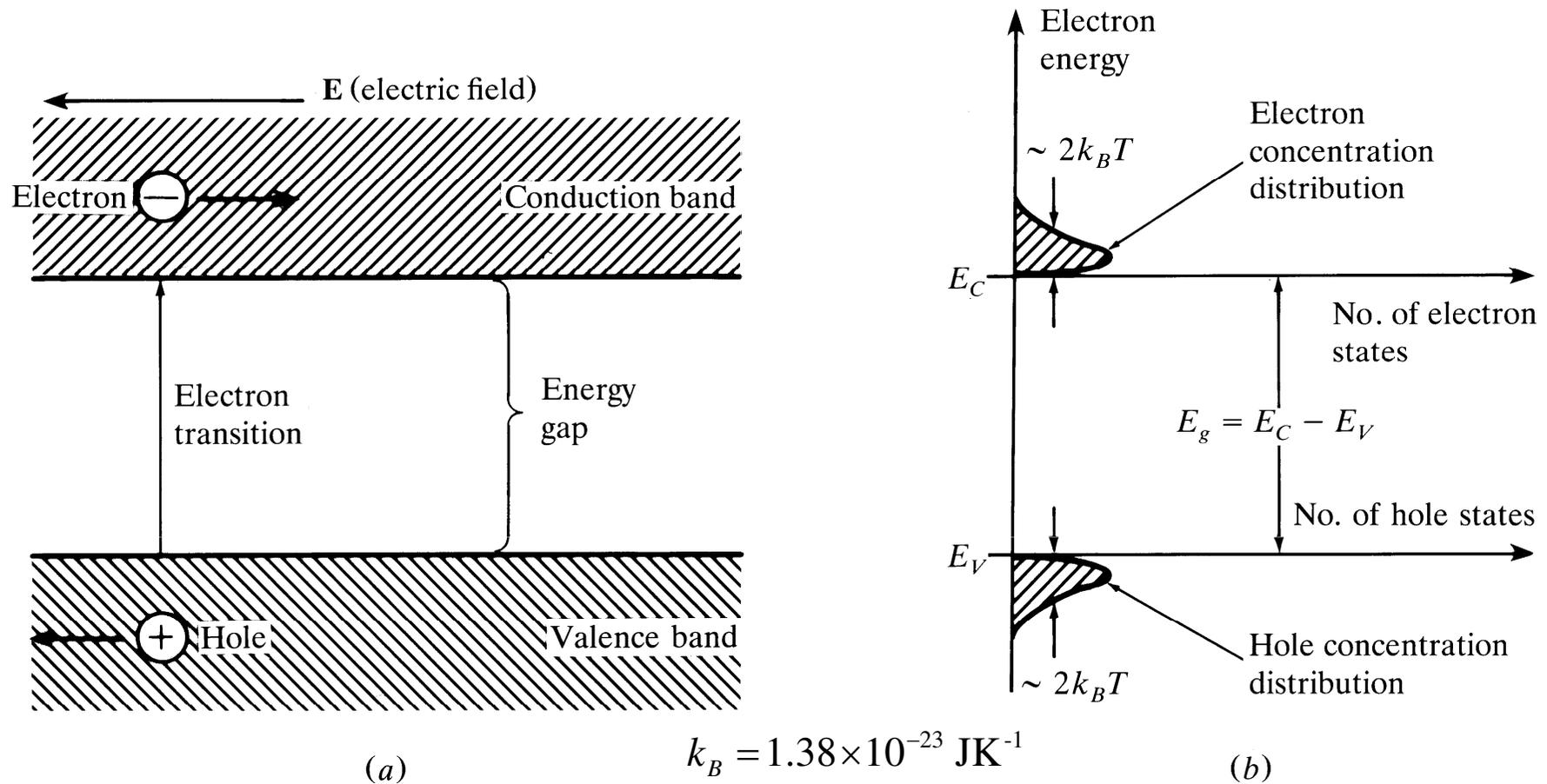

- a) Energy level diagrams showing the excitation of an electron from the valence band to the conduction band. The resultant free electron can freely move under the application of electric field.
- b) Equal electron & hole concentrations in an intrinsic semiconductor created by the thermal excitation of electrons across the band gap

# *n*-Type Semiconductor

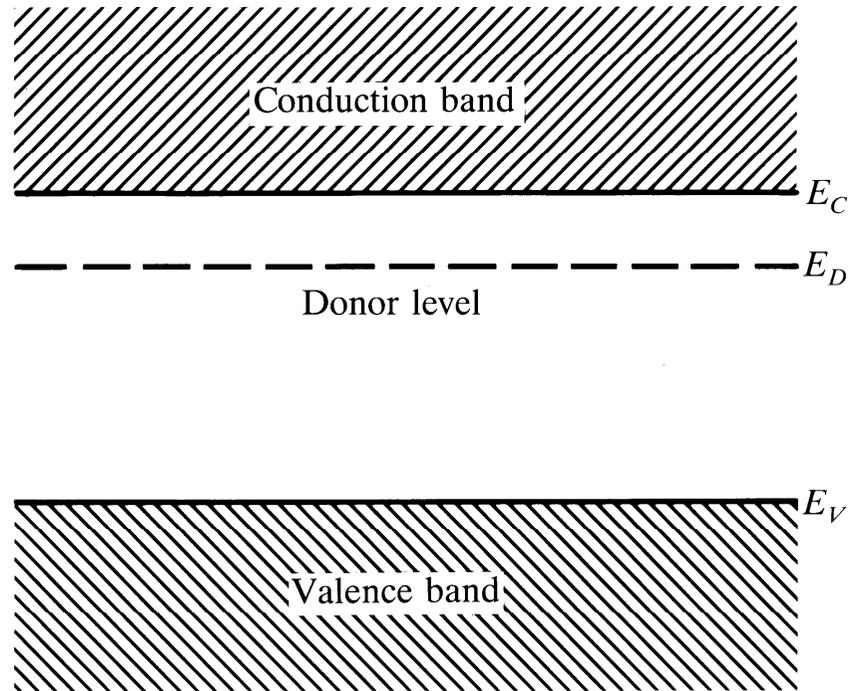

(a)

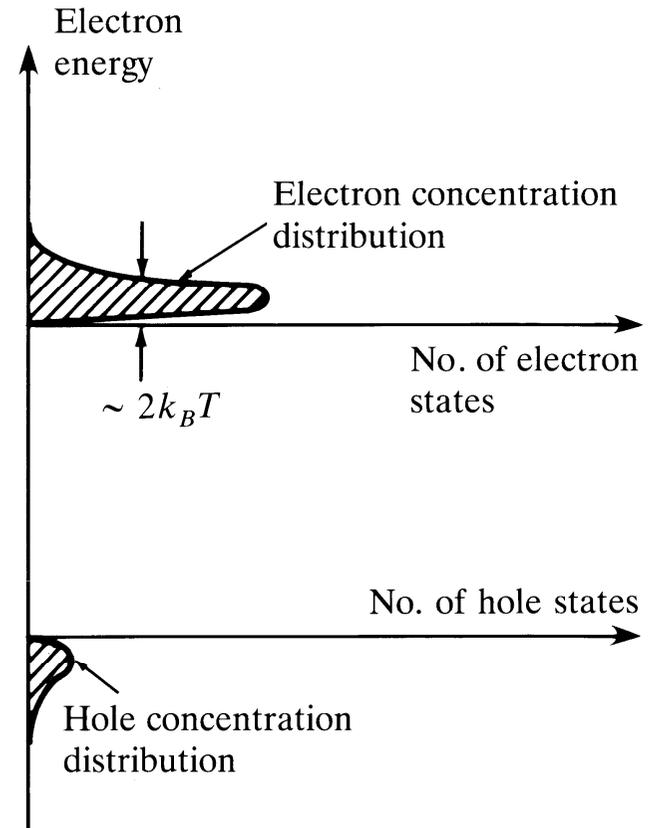

(b)

- a) Donor level in an *n*-type semiconductor.
- b) The ionization of donor impurities creates an increased electron concentration distribution.

# $p$ -Type Semiconductor

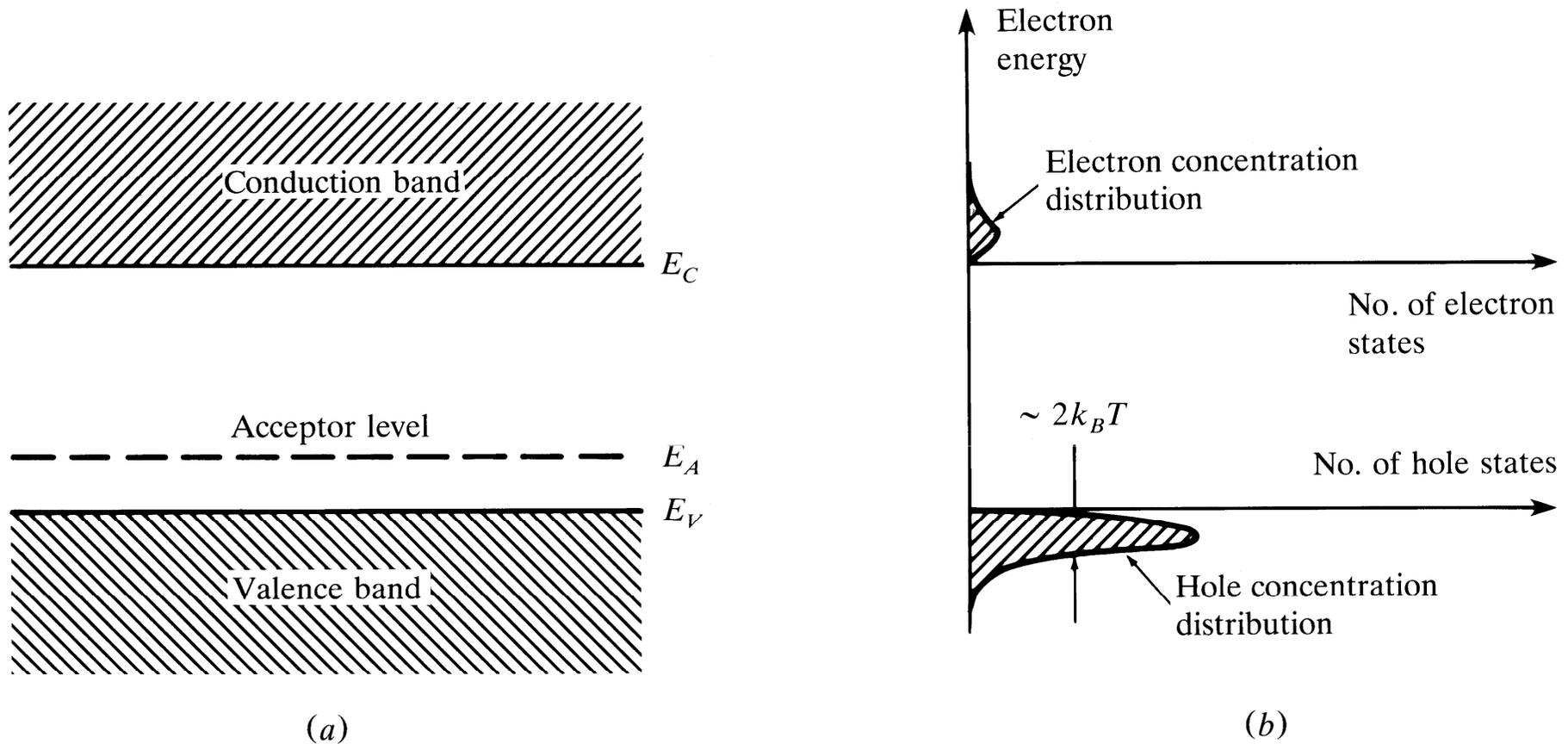

- a) Acceptor level in an  $p$ -type semiconductor.
- b) The ionization of acceptor impurities creates an increased hole concentration distribution

# Intrinsic & Extrinsic Materials

- Intrinsic material: A perfect material with no impurities.

$$n = p = n_i \propto \exp\left(-\frac{E_g}{2k_B T}\right) \quad [4-1]$$

$n$  &  $p$  &  $n_i$  are the electron, hole & intrinsic concentrations respectively.

$E_g$  is the gap energy,  $T$  is Temperature.

- Extrinsic material: donor or acceptor type semiconductors.

$$pn = n_i^2 \quad [4-2]$$

- Majority carriers: electrons in  $n$ -type or holes in  $p$ -type.
- Minority carriers: holes in  $n$ -type or electrons in  $p$ -type.
- The operation of semiconductor devices is essentially based on the **injection** and **extraction** of minority carriers.

# The *pn* Junction

Electron diffusion across a *pn* junction creates a barrier potential (electric field) in the depletion region.

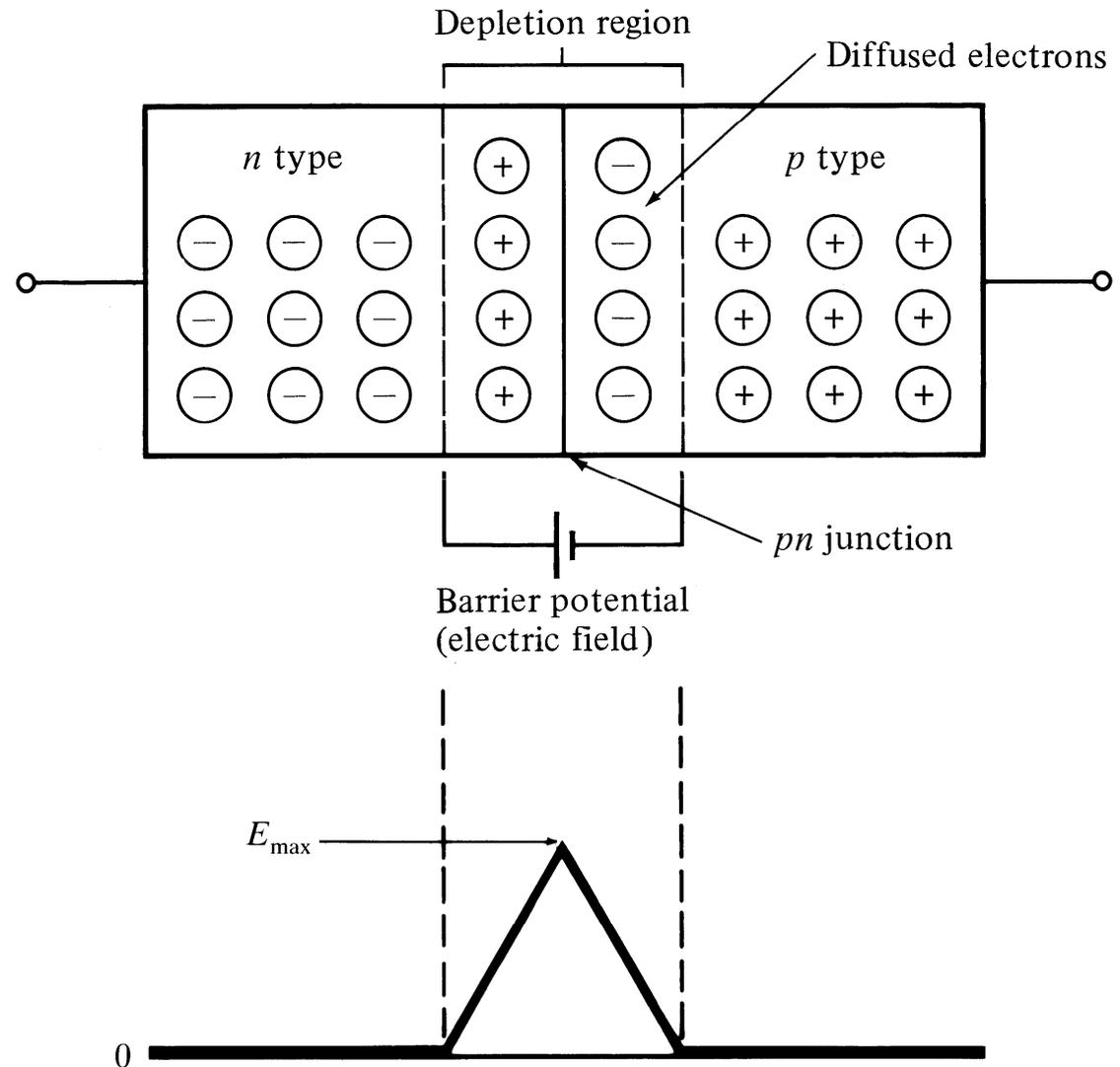

# Reverse-biased $pn$ Junction

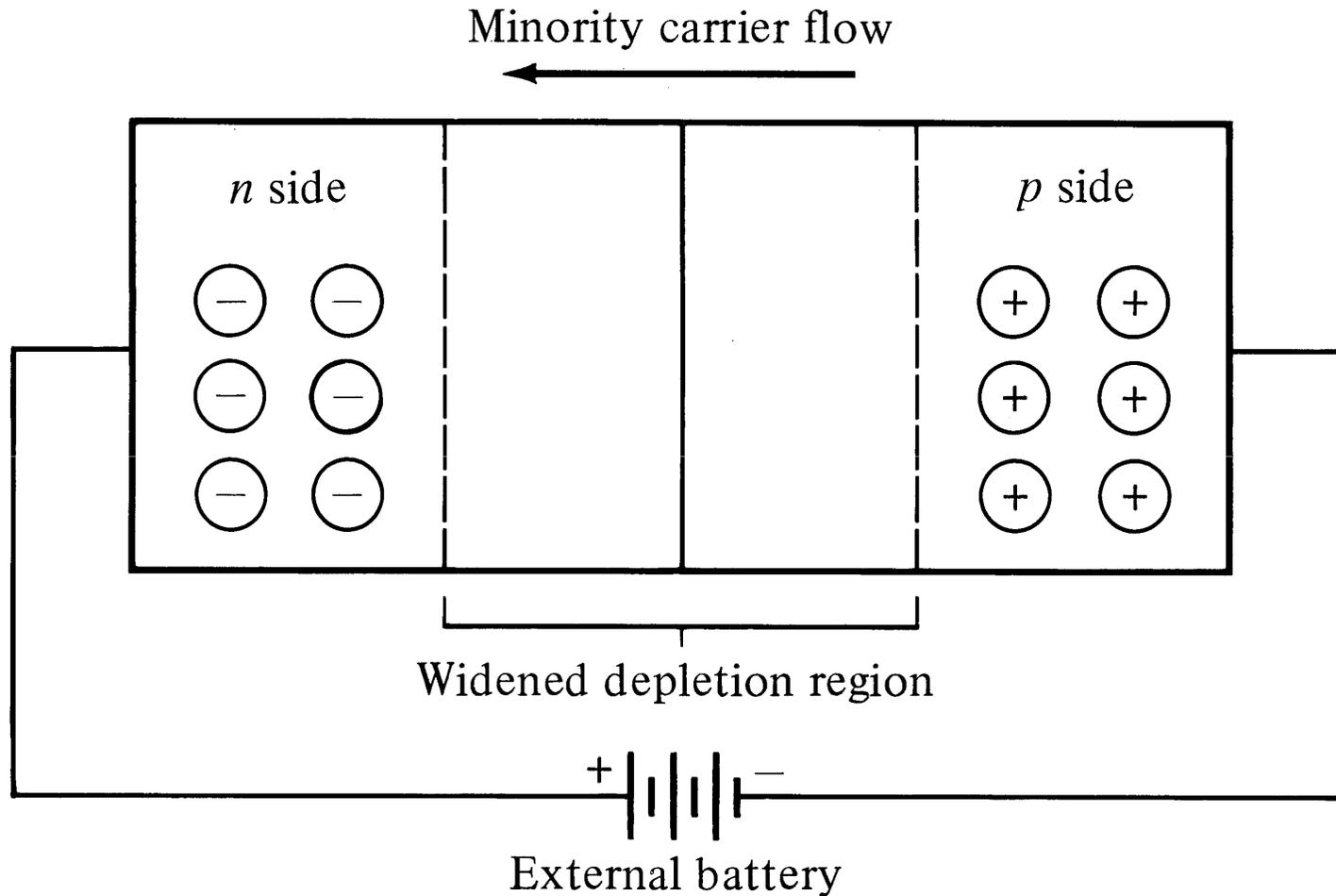

A reverse bias widens the depletion region, but allows minority carriers to move freely with the applied field.

# Forward-biased $pn$ Junction

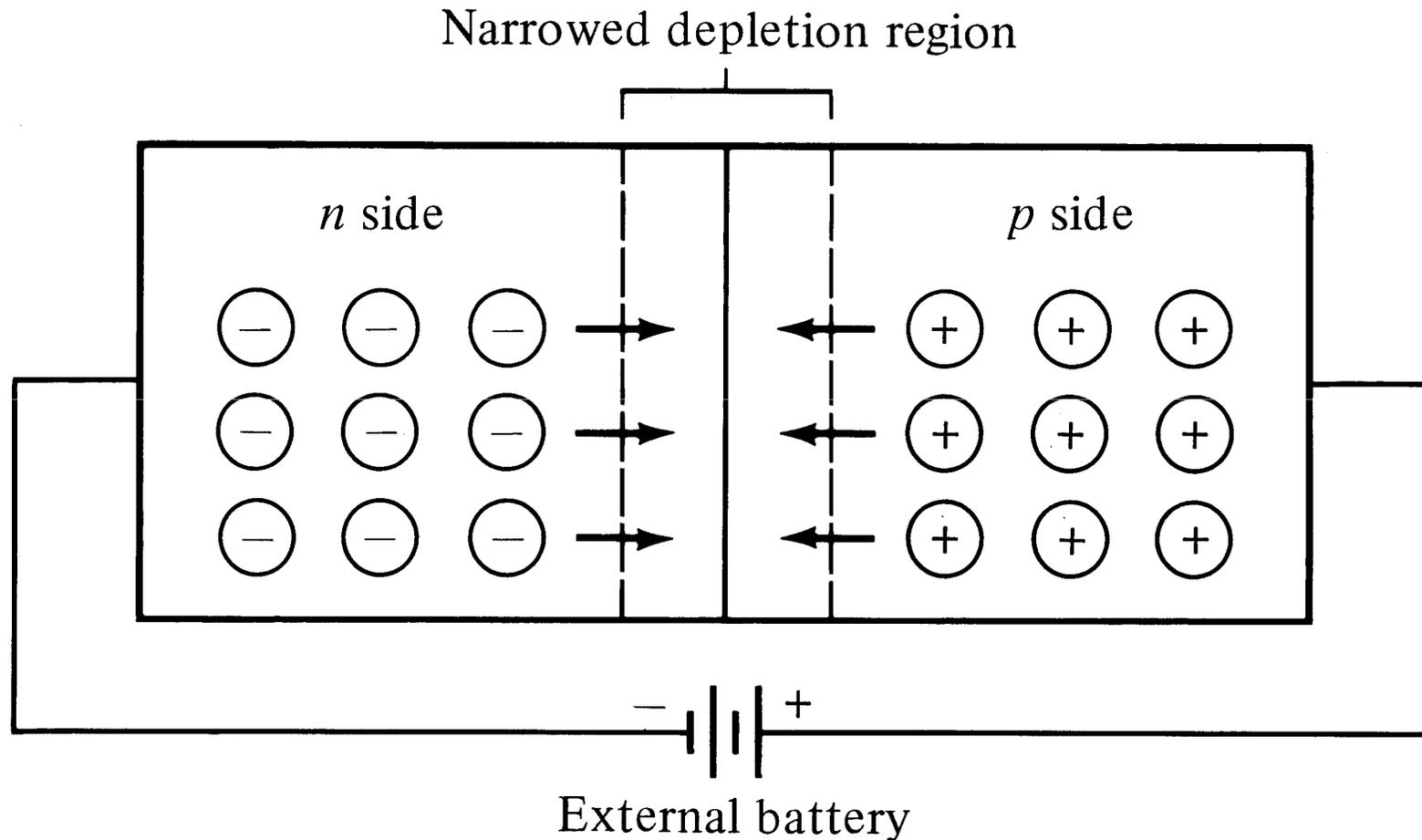

Lowering the barrier potential with a forward bias allows majority carriers to diffuse across the junction.

# Direct Band Gap Semiconductors

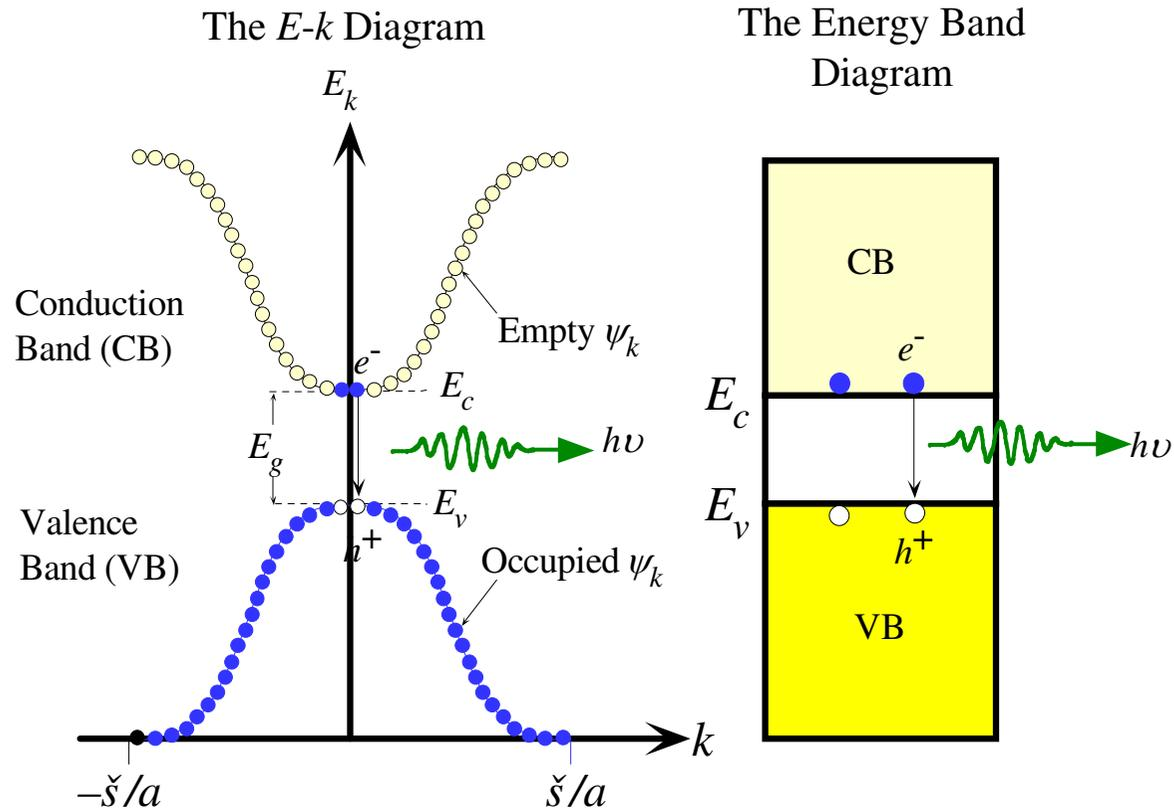

The  $E-k$  diagram of a direct bandgap semiconductor such as GaAs. The  $E-k$  curve consists of many discrete points with each point corresponding to a possible state, wavefunction  $\psi_k(x)$ , that is allowed to exist in the crystal. The points are so close that we normally draw the  $E-k$  relationship as a continuous curve. In the energy range  $E_v$  to  $E_c$  there are no points ( $\psi_k(x)$  solutions).

# Indirect Band Gap Semiconductors

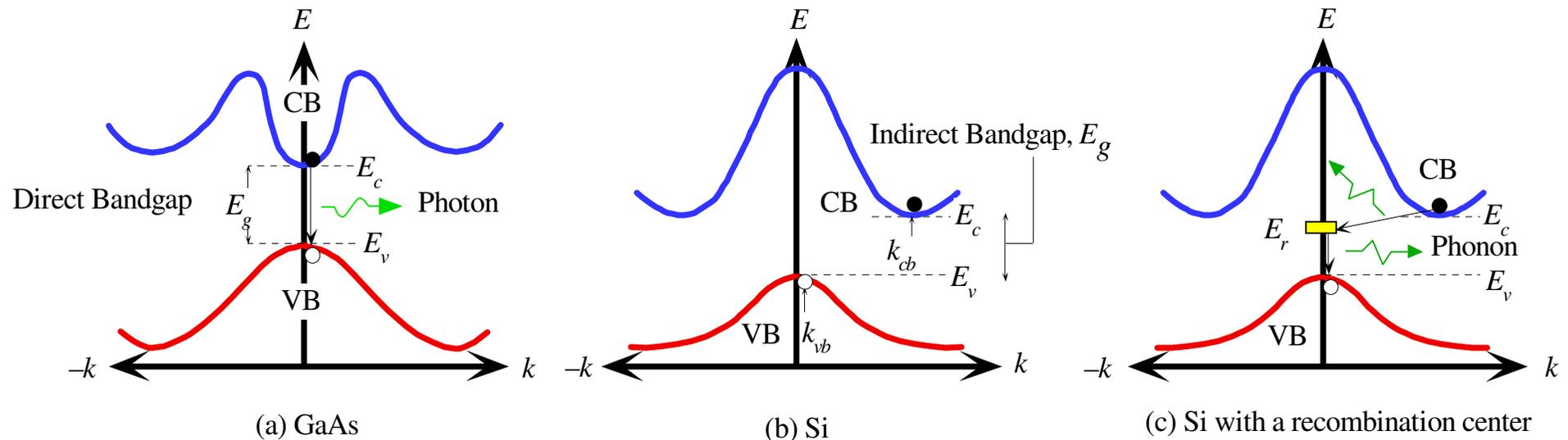

(a) In GaAs the minimum of the CB is directly above the maximum of the VB. GaAs is therefore a direct bandgap semiconductor. (b) In Si, the minimum of the CB is displaced from the maximum of the VB and Si is an indirect bandgap semiconductor. (c) Recombination of an electron and a hole in Si involves a recombination center .



# Light-Emitting Diodes (LEDs)

- For photonic communications requiring data rate 100-200 Mb/s with multimode fiber with tens of microwatts, LEDs are usually the best choice.
- LED configurations being used in photonic communications:
  - 1- Surface Emitters (Front Emitters)
  - 2- Edge Emitters

Cross-section drawing of a typical GaAlAs double heterostructure light emitter. In this structure,  $x > y$  to provide for both carrier confinement and optical guiding.

b) Energy-band diagram showing the active region, the electron & hole barriers which confine the charge carriers to the active layer.

c) Variations in the refractive index; the lower refractive index of the material in regions 1 and 5 creates an optical barrier around the waveguide because of the higher band-gap energy of this material.

(a)

Metal contact	<i>n</i> -type GaAs substrate	<i>n</i> -type Ga <sub>1-x</sub> Al <sub>x</sub> As Light guiding and carrier confinement ~ 1 μm	<i>n</i> -type Ga <sub>1-y</sub> Al <sub>y</sub> As Recombination region ~ 0.3 μm	<i>p</i> -type Ga <sub>1-x</sub> Al <sub>x</sub> As Light guiding and carrier confinement ~ 1 μm	<i>p</i> -type GaAs Metal contact improvement layer ~ 1 μm	Metal contact
---------------	-------------------------------	--	---	--	--	---------------

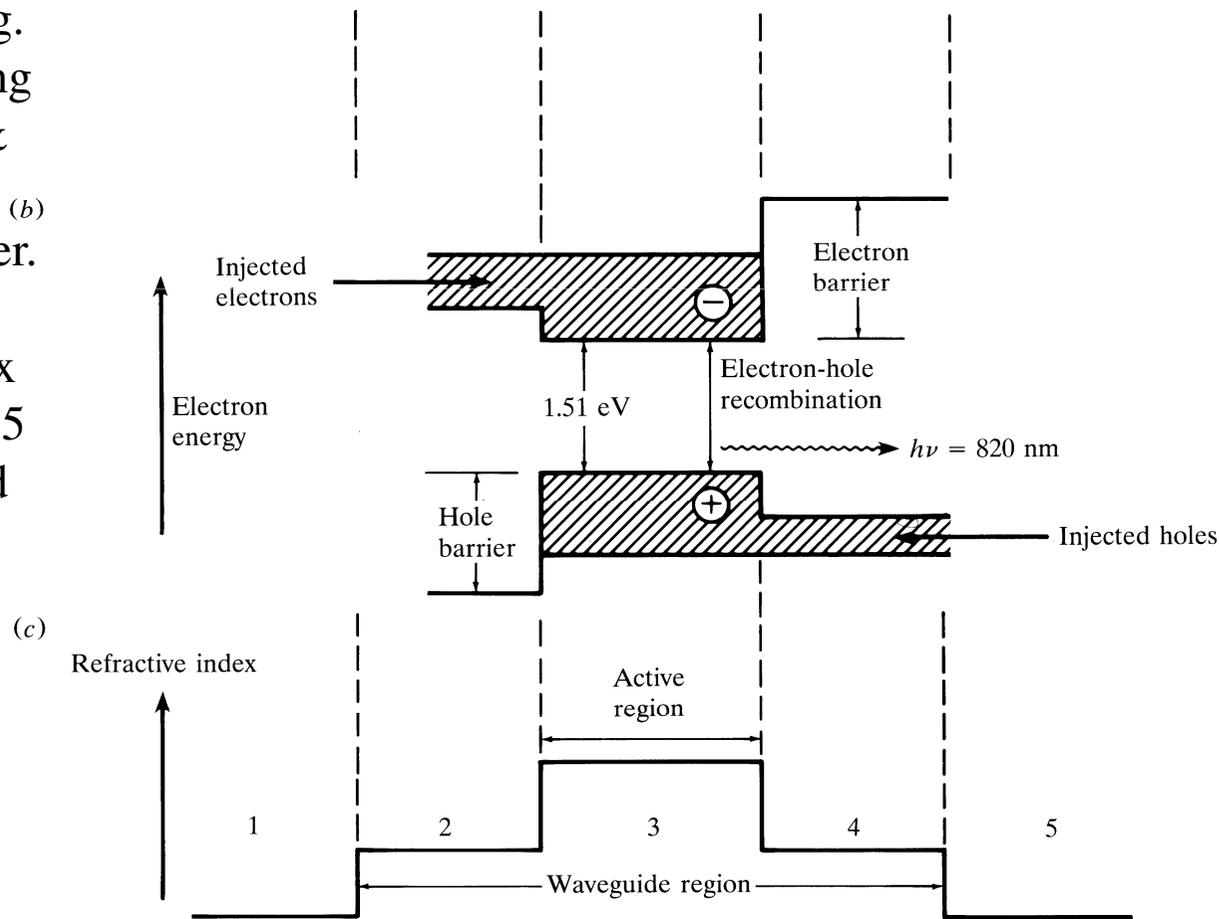

$$\lambda(\mu\text{m}) = \frac{1.240}{E_g(\text{eV})}$$

# Surface-Emitting LED

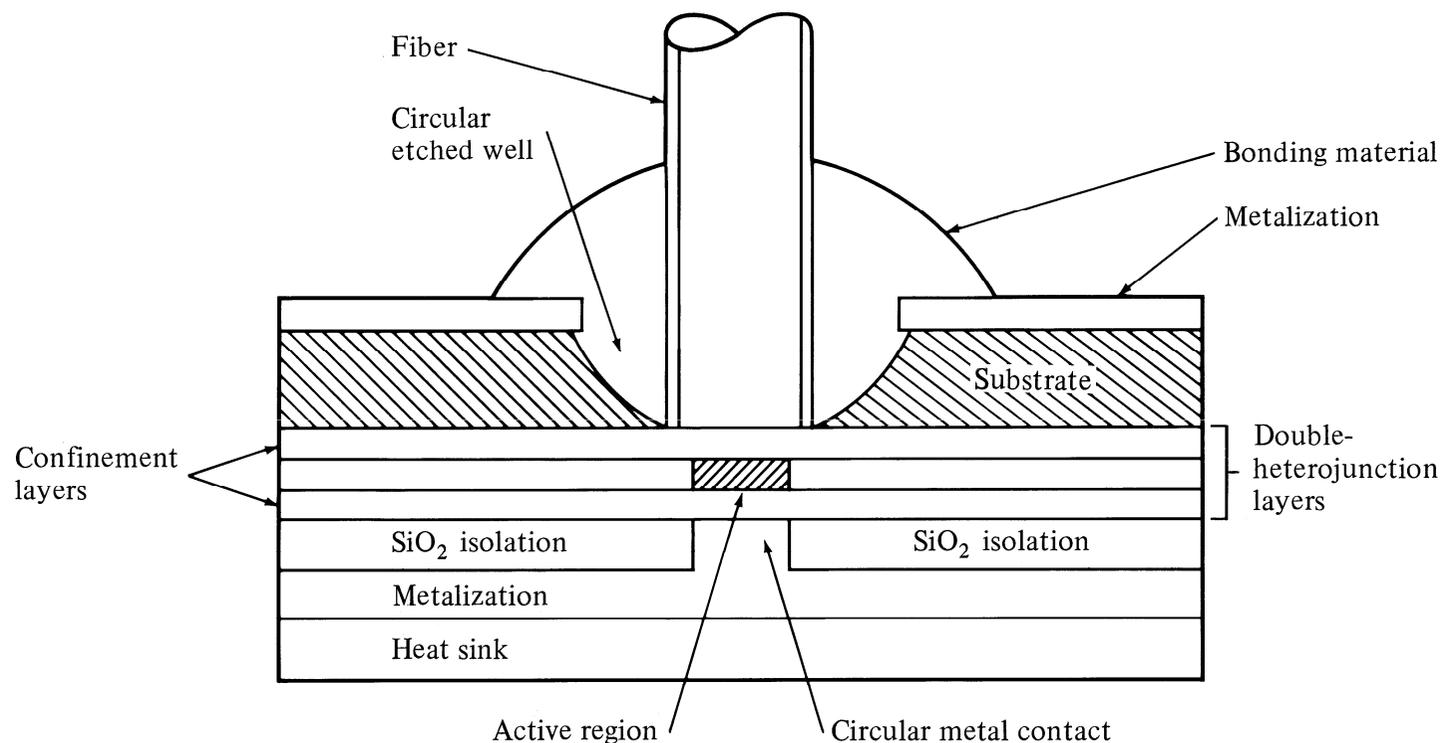

Schematic of high-radiance surface-emitting LED. The active region is limited to a circular cross section that has an area compatible with the fiber-core end face.

# Edge-Emitting LED

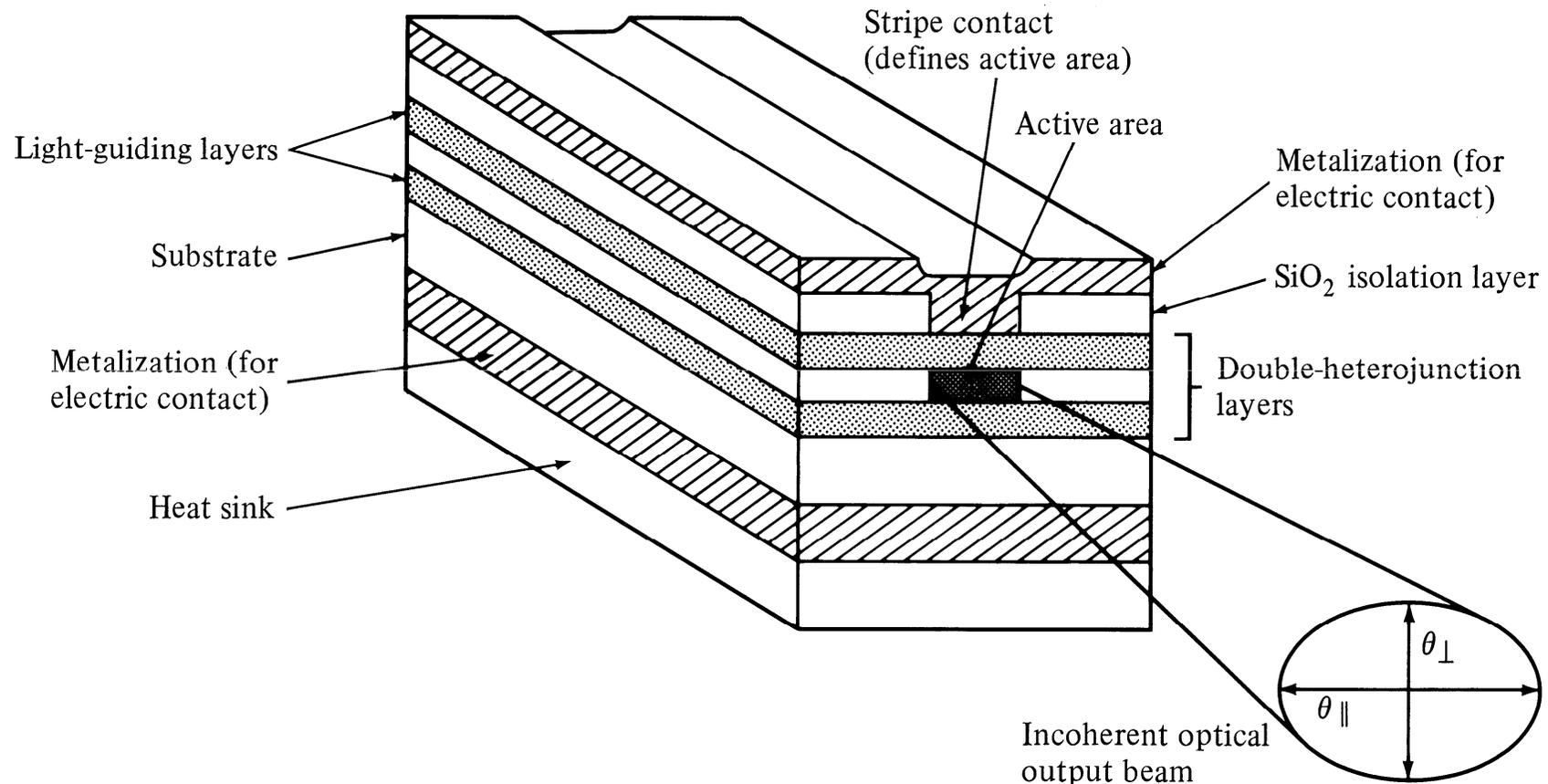

Schematic of an edge-emitting double heterojunction LED. The output beam is Lambertian in the plane of junction ( $\theta_{\parallel} = 120^{\circ}$ ) and highly directional perpendicular to pn junction ( $\theta_{\perp} = 30^{\circ}$ ). They have high quantum efficiency & fast response.

# Light Source Material

- Most of the light sources contain III-V ternary & quaternary compounds.
- $\text{Ga}_{1-x}\text{Al}_x\text{As}$  by varying  $x$  it is possible to control the band-gap energy and thereby the emission wavelength over the range of 800 nm to 900 nm. The spectral width is around 20 to 40 nm.
- $\text{In}_{1-x}\text{Ga}_x\text{As}_y\text{P}_{1-y}$  By changing  $0 < x < 0.47$ ;  $y$  is approximately  $2.2x$ , the emission wavelength can be controlled over the range of 920 nm to 1600 nm. The spectral width varies from 70 nm to 180 nm when the wavelength changes from 1300 nm to 1600 nm. These materials are lattice matched.

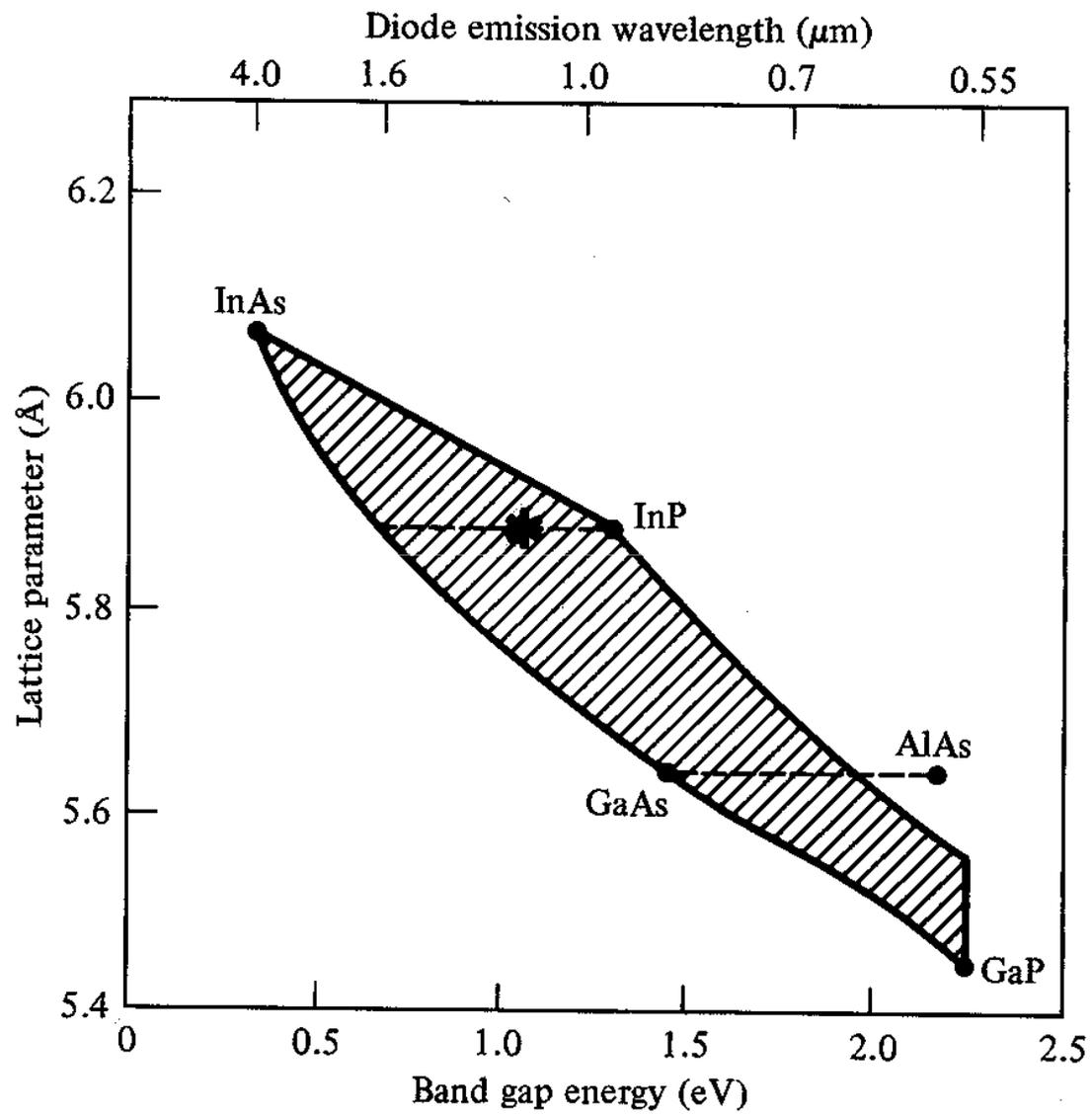

# Spectral width of LED types

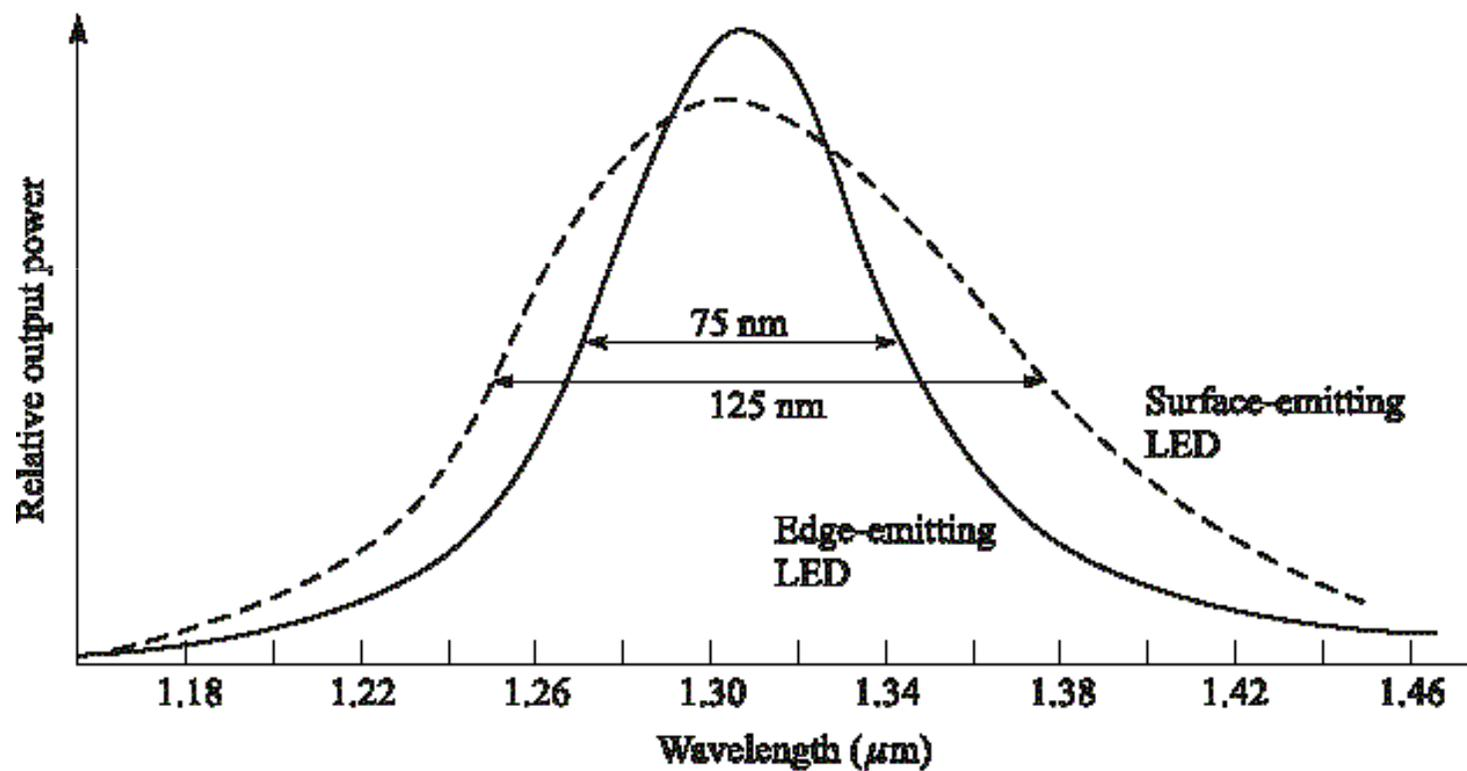

# Rate equations, Quantum Efficiency & Power of LEDs

- When there is no external carrier injection, the excess density decays exponentially due to electron-hole recombination.

$$n(t) = n_0 e^{-t/\tau} \quad [4-4]$$

- $n$  is the excess carrier density,

$n_0$  : initial injected excess electron density

$\tau$  : carrier lifetime.

- Bulk recombination rate  $R$ :

$$R = -\frac{dn}{dt} = \frac{n}{\tau} \quad [4-5]$$

- Bulk recombination rate ( $R$ )=Radiative recombination rate + nonradiative recombination rate

bulk recombination rate ( $R = 1/\tau$ ) =

radiative recombination rate ( $R_r = 1/\tau_r$ ) + nonradiative recombination rate ( $R_{nr} = 1/\tau_{nr}$ )

With an external supplied current density of  $J$  the rate equation for the electron-hole recombination is:

$$\frac{dn(t)}{dt} = \frac{J}{qd} - \frac{n}{\tau} \quad [4-6]$$

$q$  : charge of the electron;  $d$  : thickness of recombination region

In equilibrium condition:  $dn/dt=0$

$$n = \frac{J\tau}{qd} \quad [4-7]$$

## Internal Quantum Efficiency & Optical Power

$$\eta_{\text{int}} = \frac{R_r}{R_r + R_{nr}} = \frac{\tau_{nr}}{\tau_r + \tau_{nr}} = \frac{\tau}{\tau_r} \quad [4-8]$$

$\eta_{\text{int}}$  : internal quantum efficiency in the active region

Optical power generated internally in the active region in the LED is:

$$P_{\text{int}} = \eta_{\text{int}} \frac{I}{q} h\nu = \eta_{\text{int}} \frac{hcI}{q\lambda} \quad [4-9]$$

$P_{\text{int}}$  : Internal optical power,

$I$  : Injected current to active region

# External Quantum Efficiency

$$\eta_{\text{ext}} = \frac{\text{\# of photons emitted from LED}}{\text{\# of LED internally generated photons}} \quad [4-10]$$

- In order to calculate the external quantum efficiency, we need to consider the reflection effects at the surface of the LED. If we consider the LED structure as a simple 2D slab waveguide, only light falling within a cone defined by critical angle will be emitted from an LED.

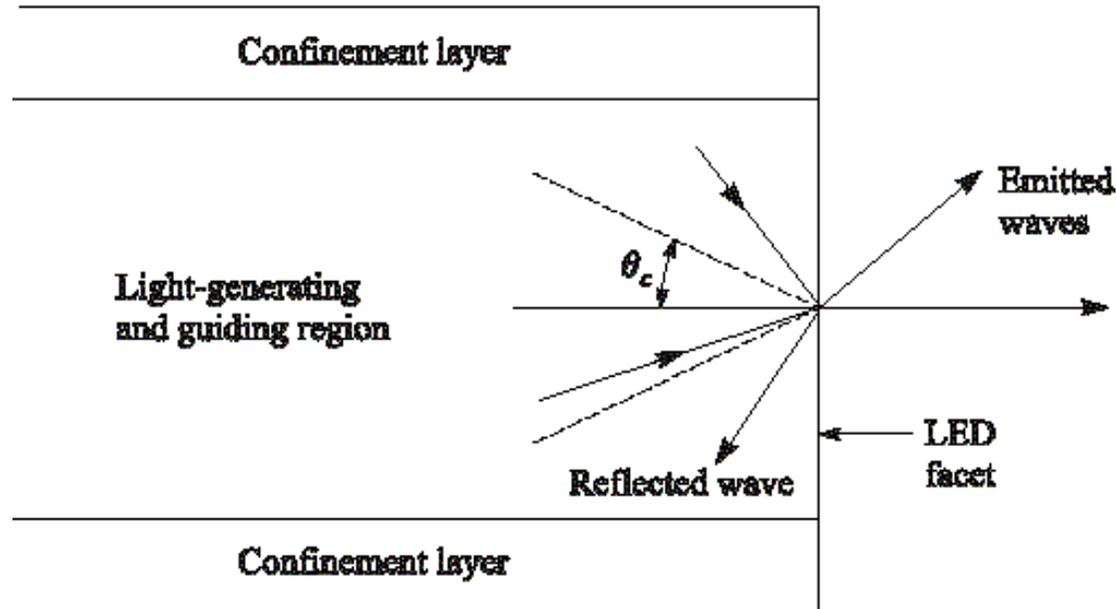

$$\eta_{\text{ext}} = \frac{1}{4\pi} \int_0^{\phi_c} T(\phi) (2\pi \sin \phi) d\phi \quad [4-11]$$

$$T(\phi) : \text{Fresnel Transmission Coefficient} \approx T(0) = \frac{4n_1 n_2}{(n_1 + n_2)^2} \quad [4-12]$$

$$\text{If } n_2 = 1 \Rightarrow \eta_{\text{ext}} \approx \frac{1}{n_1 (n_1 + 1)^2} \quad [4-13]$$

$$\text{LED emitted optical power, } P = \eta_{\text{ext}} P_{\text{int}} \approx \frac{P_{\text{int}}}{n_1 (n_1 + 1)^2} \quad [4-14]$$

# Modulation of LED

- The frequency response of an LED depends on:
  - 1- Doping level in the active region
  - 2- Injected carrier lifetime in the recombination region,  $\tau_i$  .
  - 3- Parasitic capacitance of the LED
- If the drive current of an LED is modulated at a frequency of  $\omega$  the output optical power of the device will vary as:

$$P(\omega) = \frac{P_0}{\sqrt{1 + (\omega\tau_i)^2}} \quad [4-15]$$

- Electrical current is directly proportional to the optical power, thus we can define electrical bandwidth and optical bandwidth, separately.

$$\text{Electrical BW} = 10\log\left[\frac{P(\omega)}{P(0)}\right] = 20\log\left[\frac{I(\omega)}{I(0)}\right] \quad [4-16]$$

$P$  : electrical power,  $I$  : electrical current

$$\text{Optical BW} = 10 \log \left[ \frac{P(\omega)}{P(0)} \right] = 10 \log \left[ \frac{I(\omega)}{I(0)} \right]$$

[4-17]

$P$  : optical power,  $I$  : detected electric current,  $I \propto P$

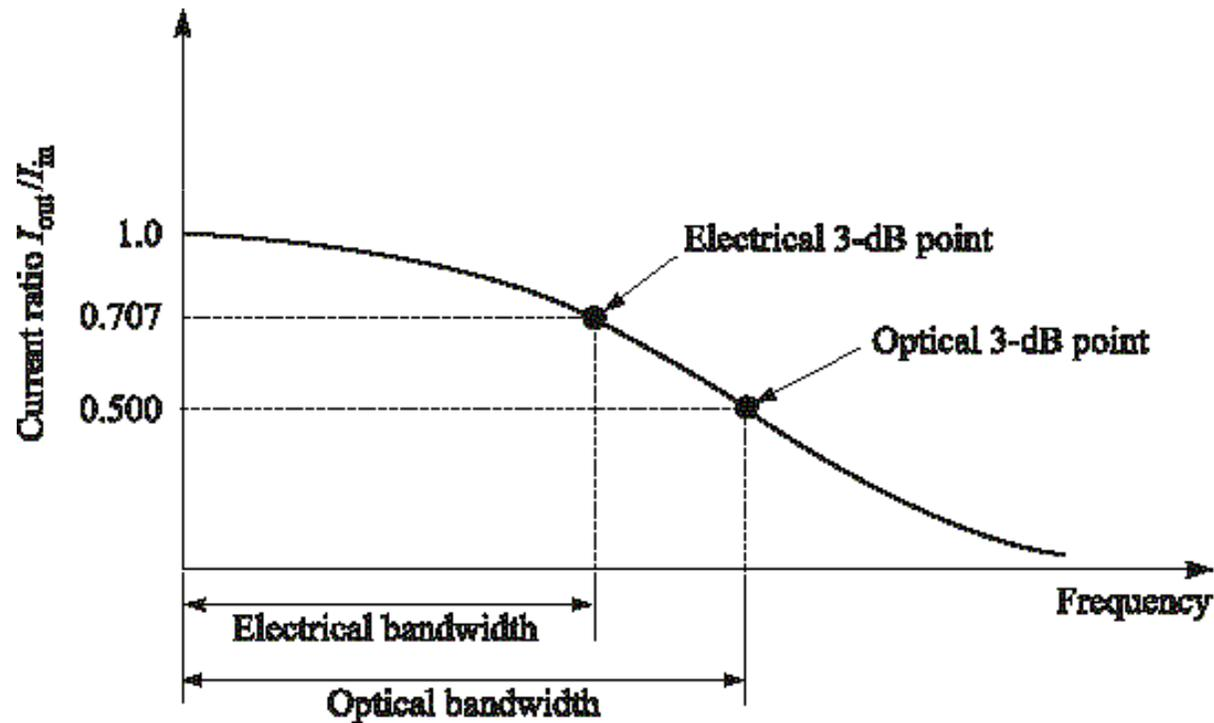

# Drawbacks & Advantages of LED

## Drawbacks

- Large line width (30-40 nm)
- Large beam width (Low coupling to the fiber)
- Low output power
- Low E/O conversion efficiency

## Advantages

- Robust
- Linear

# LASER

(Light Amplification by the Stimulated Emission of Radiation)

- Laser is an optical oscillator. It comprises a resonant optical amplifier whose output is fed back into its input with matching phase. Any oscillator contains:
  - 1- An amplifier with a gain-saturated mechanism
  - 2- A feedback system
  - 3- A frequency selection mechanism
  - 4- An output coupling scheme
- In laser, the amplifier is the pumped active medium, such as biased semiconductor region, feedback can be obtained by placing active medium in an optical resonator, such as Fabry-Perot structure, two mirrors separated by a prescribed distance. Frequency selection is achieved by resonant amplifier and by the resonators, which admits certain modes. Output coupling is accomplished by making one of the resonator mirrors partially transmitting.

# Lasing in a pumped active medium

- In thermal equilibrium the stimulated emission is essentially negligible, since the density of electrons in the excited state is very small, and optical emission is mainly because of the spontaneous emission. Stimulated emission will exceed absorption only if the population of the excited states is greater than that of the ground state. This condition is known as **Population Inversion**. Population inversion is achieved by various **pumping** techniques.
- In a semiconductor laser, population inversion is accomplished by injecting electrons into the material to fill the lower energy states of the conduction band.

# Pumped active medium

- Three main process for laser action:
  - 1- Photon absorption
  - 2- Spontaneous emission
  - 3- Stimulated emission

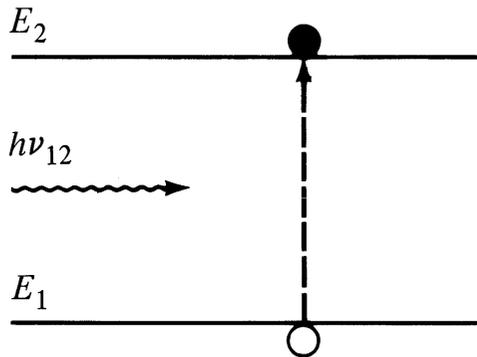

(a) Absorption

**Energy  
absorbed from  
the incoming  
photon**

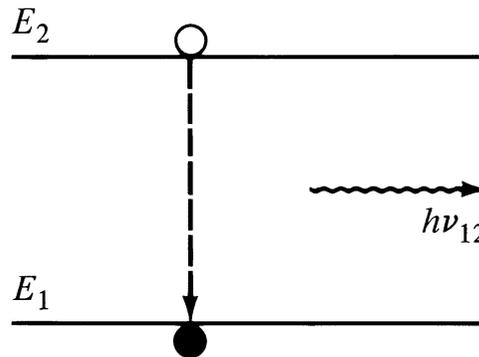

(b) Spontaneous emission

**Random  
release of  
energy**

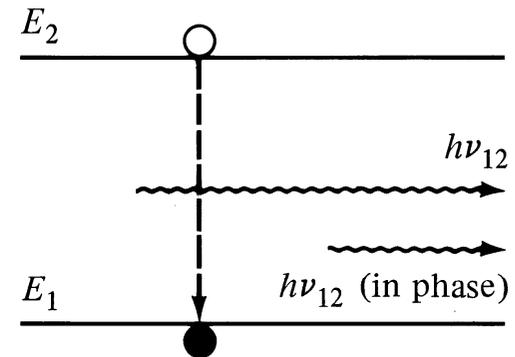

(c) Stimulated emission

**Coherent  
release of  
energy**

# Howling Dog Analogy

1. absorption: a dog in the ground state might hear the howl from another dog and become excited, thus making a transition to the excited state.
2. spontaneous emission: a dog in the excited state might randomly let out a howl, which, through release of tension, enables him to relax to the ground state.
3. stimulated emission: a dog in the excited state might be stimulated to let out a howl when he hears the howl from another dog. The single howl becomes two howls voiced simultaneously, thus sounding like one howl with twice the intensity!

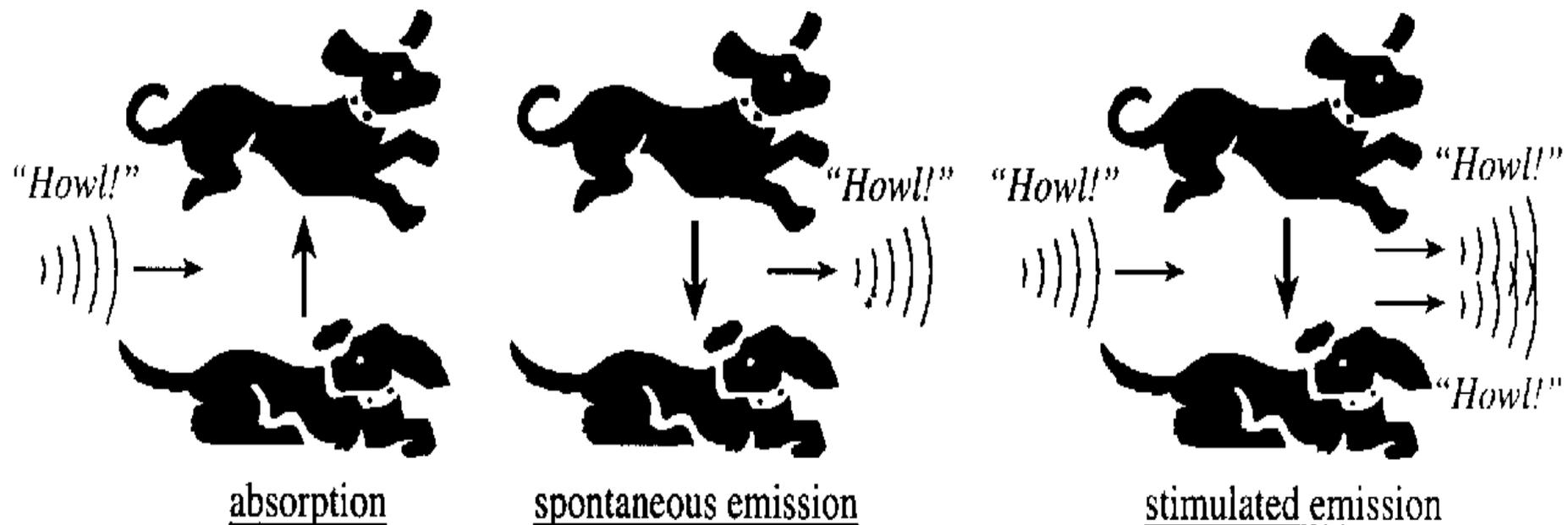

# In Stimulated Emission incident and stimulated photons will have

- Identical **energy** → Identical wavelength → Narrow linewidth
- Identical **direction** → Narrow beam width
- Identical **phase** → Coherence and
- Identical **polarization**

# Stimulated Emission

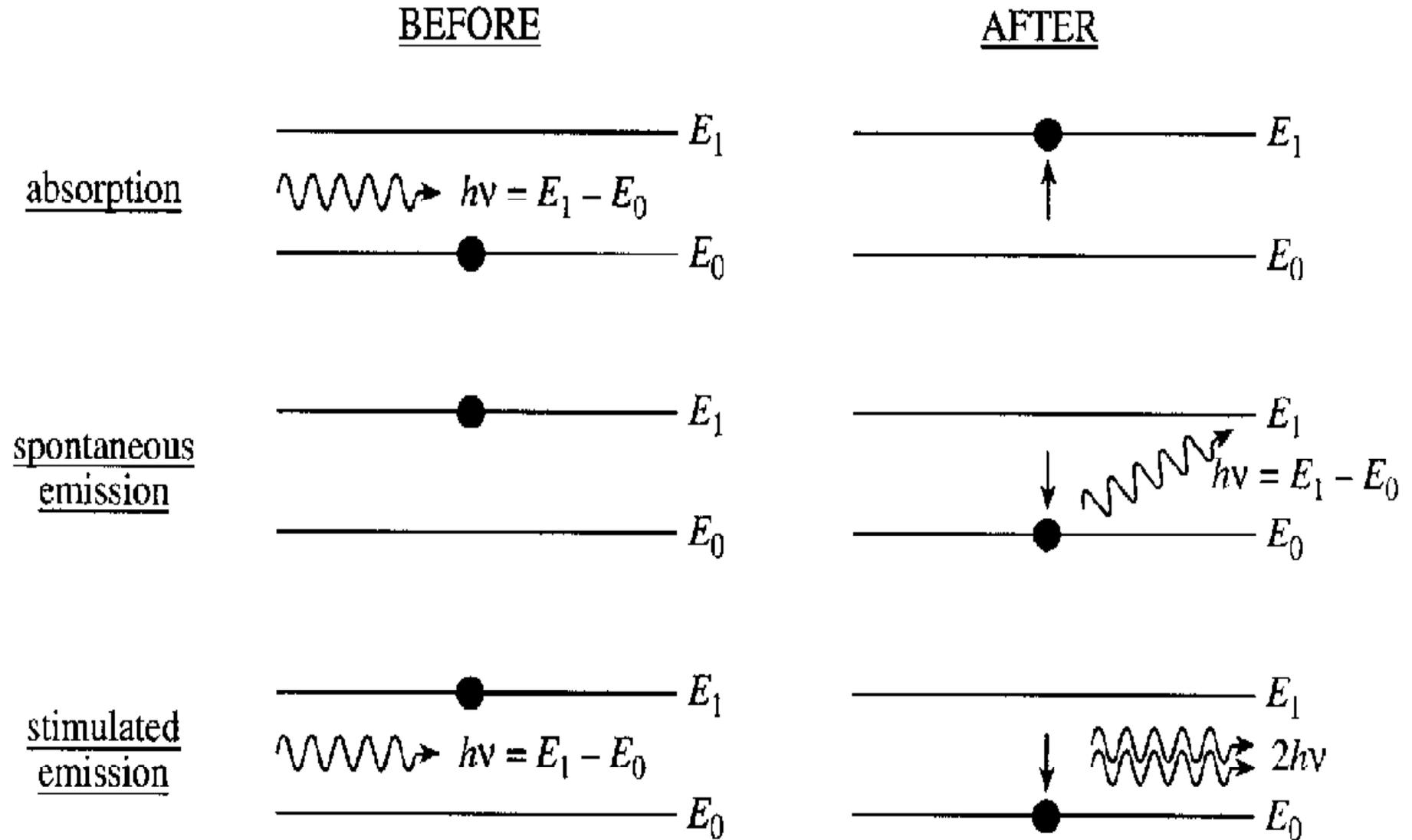

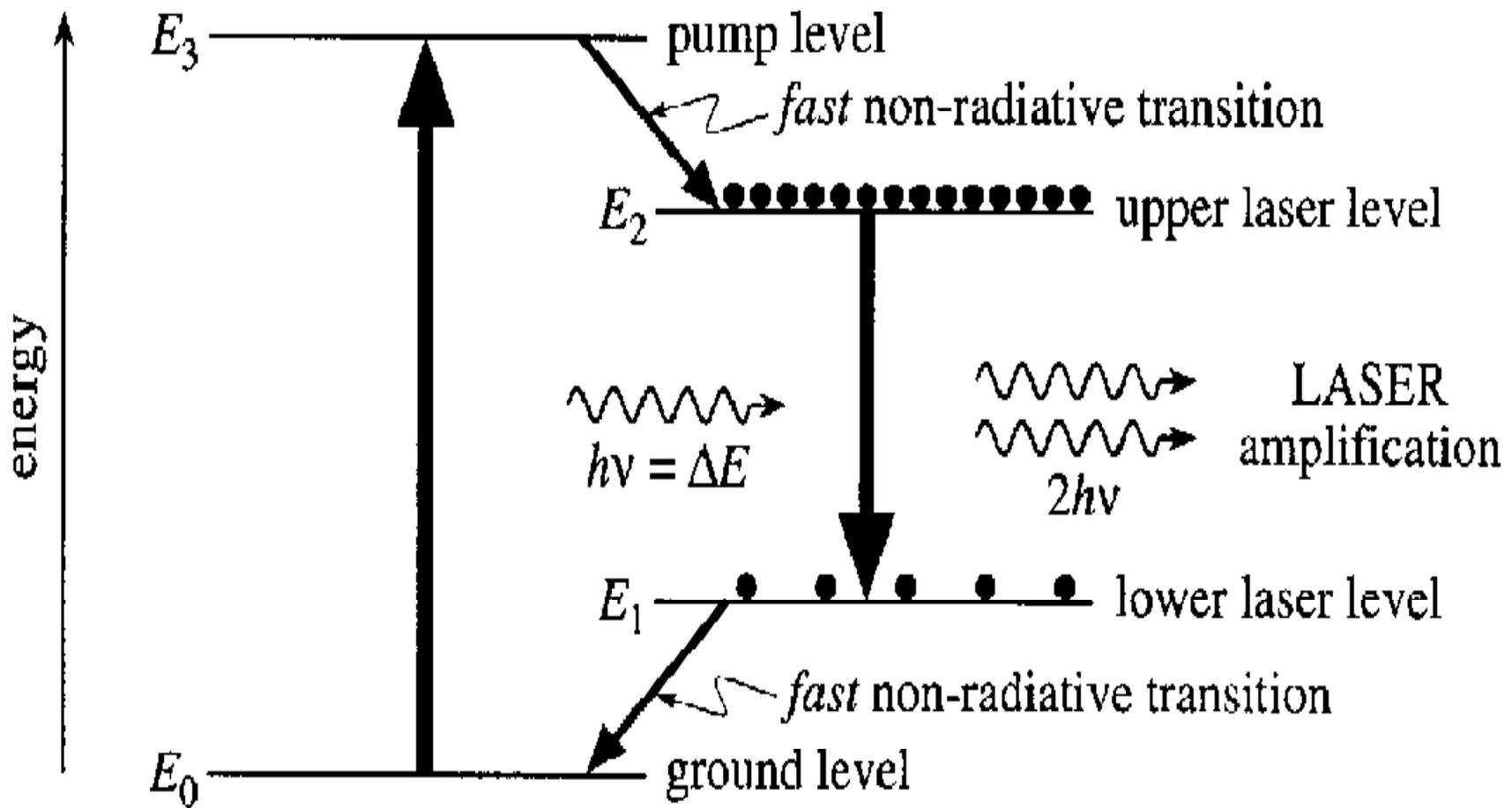
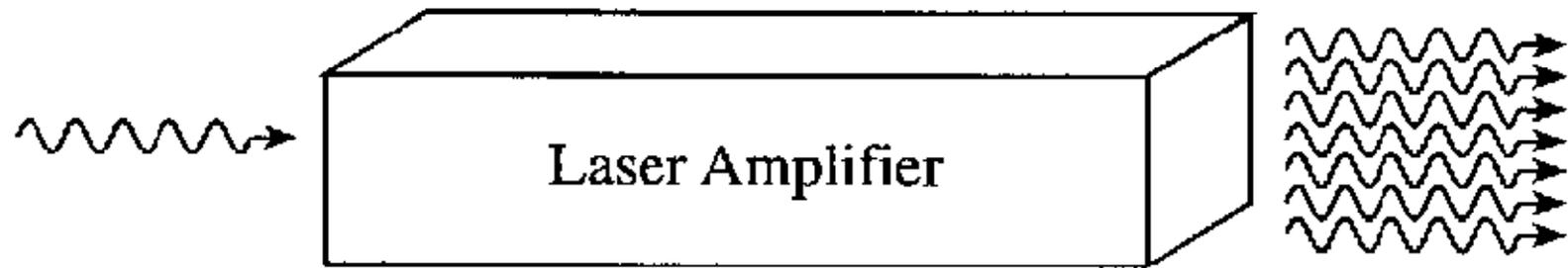

# Fabry-Perot Resonator

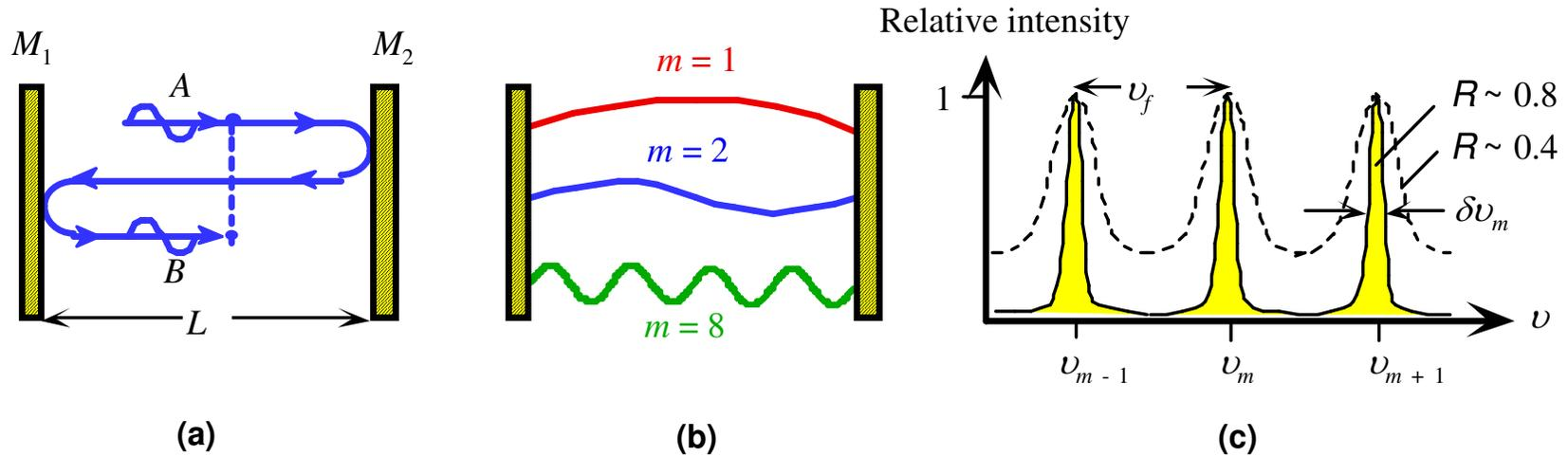

$$\text{Resonant modes : } kL = m\pi \quad m = 1, 2, 3, \dots$$

Schematic illustration of the Fabry-Perot optical cavity and its properties. (a) Reflected waves interfere. (b) Only standing EM waves, *modes*, of certain wavelengths are allowed in the cavity. (c) Intensity vs. frequency for various modes.  $R$  is mirror reflectance and lower  $R$  means higher loss from the cavity.

© 1999 S.O. Kasap, *Optoelectronics* (Prentice Hall)

$$I_{trans} = I_{inc} \frac{(1-R)^2}{(1-R)^2 + 4R \sin^2(kL)}$$

[4-18]

$R$ : reflectance of the optical intensity,  $k$ : optical wavenumber

# Mirror Reflections

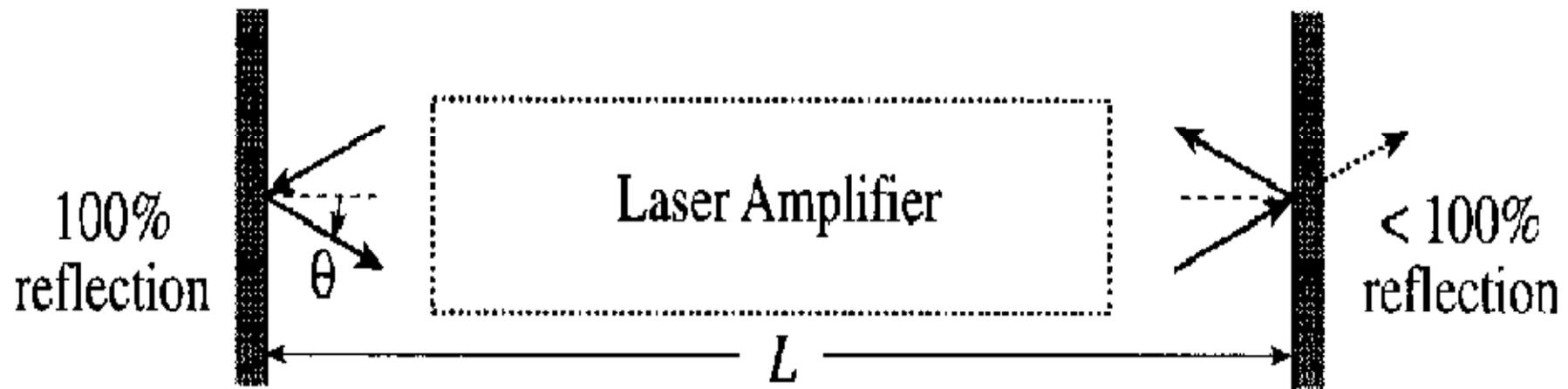

# How a Laser Works

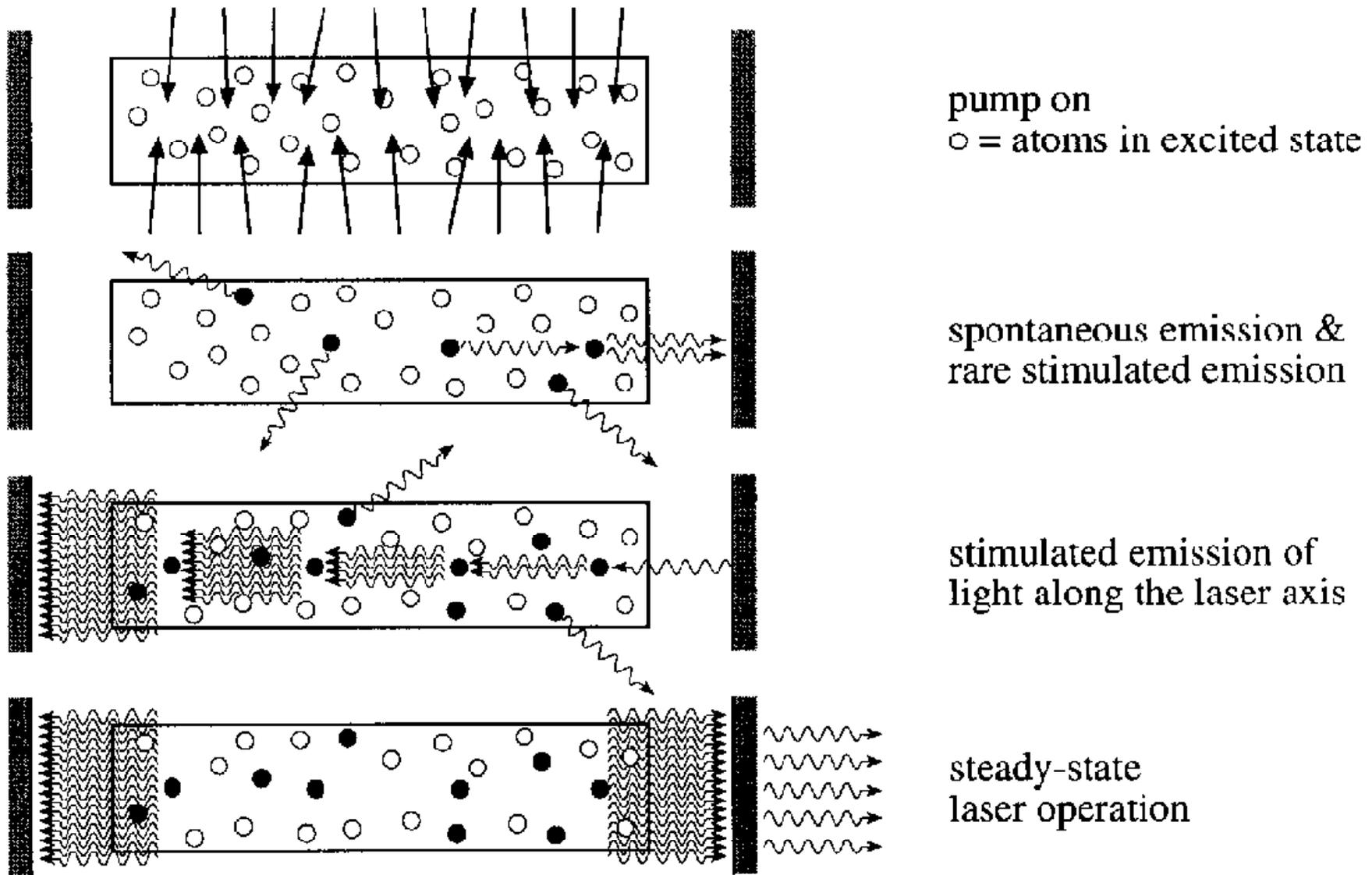

# Laser Diode

- Laser diode is an improved LED, in the sense that uses stimulated emission in semiconductor from optical transitions between distribution energy states of the valence and conduction bands with optical resonator structure such as Fabry-Perot resonator with both optical and carrier confinements.

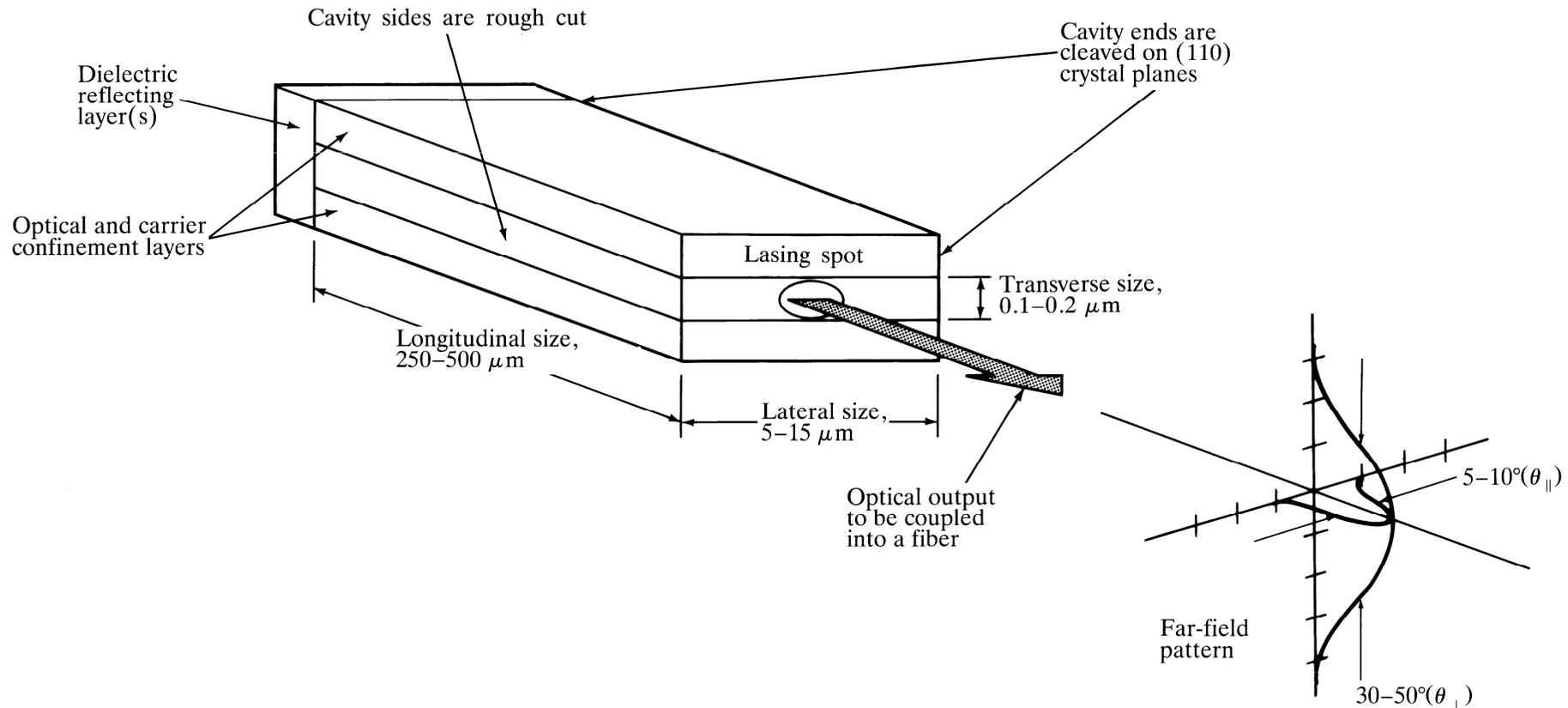

# Laser Diode Characteristics

- Nanosecond & even picosecond response time (GHz BW)
- Spectral width of the order of nm or less
- High output power (tens of mW)
- Narrow beam (good coupling to single mode fibers)
  
- Laser diodes have three distinct radiation modes namely, **longitudinal, lateral and transverse** modes.
  
- In laser diodes, end mirrors provide strong optical feedback in longitudinal direction, so by roughening the edges and cleaving the facets, the radiation can be achieved in longitudinal direction rather than lateral direction.

# DFB(Distributed FeedBack) Lasers

- In DFB lasers, the optical resonator structure is due to the incorporation of Bragg grating or periodic variations of the refractive index into multilayer structure along the length of the diode.

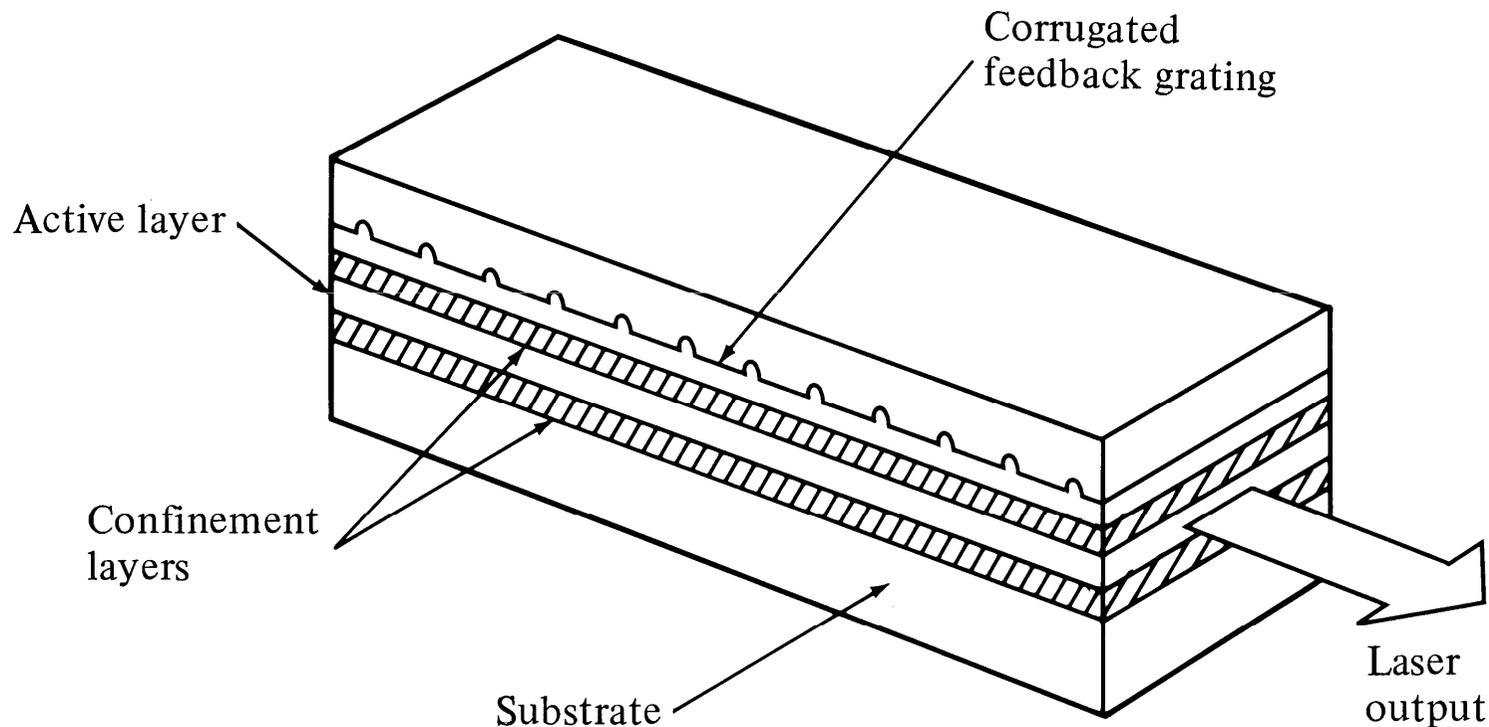

**The optical feedback is provided by fiber Bragg Gratings  
→ Only one wavelength get positive feedback**

# Laser Operation & Lasing Condition

- To determine the lasing condition and resonant frequencies, we should focus on the optical wave propagation along the longitudinal direction, z-axis. The optical field intensity,  $I$ , can be written as:

$$I(z, t) = I(z)e^{j(\omega t - \beta z)} \quad [4-19]$$

- Lasing is the condition at which light amplification becomes possible by virtue of population inversion. Then, stimulated emission rate into a given EM mode is proportional to the intensity of the optical radiation in that mode. In this case, the loss and gain of the optical field in the optical path determine the lasing condition. The radiation intensity of a photon at energy  $h\nu$  varies exponentially with a distance  $z$  amplified by factor  $g$ , and attenuated by factor  $\bar{\alpha}$  according to the following relationship:

$$I(z) = I(0) \exp[(\Gamma g(h\nu) - \bar{\alpha}(h\nu))z] \quad [4-20]$$

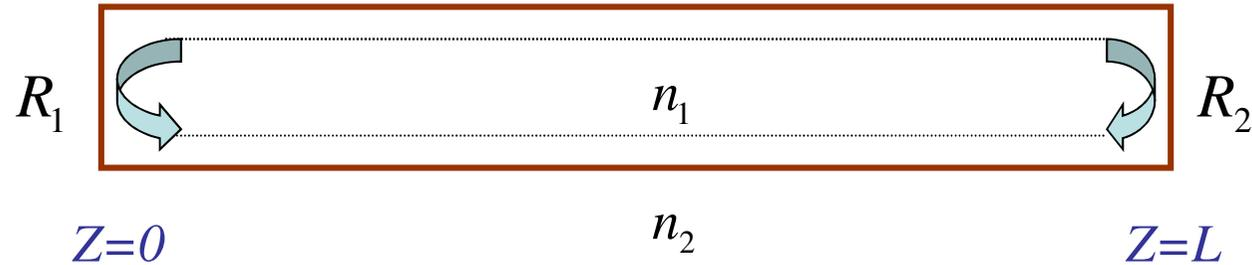

$$I(2L) = I(0)R_1R_2 \exp[(\Gamma g(h\nu) - \bar{\alpha}(h\nu))(2L)] \quad [4-21]$$

$\Gamma$  : Optical confinement factor,  $g$  : gain coefficient

$\bar{\alpha}$  : effective absorption coefficient,  $R = \left( \frac{n_1 - n_2}{n_1 + n_2} \right)^2$

Lasing Conditions:

$$I(2L) = I(0)$$

$$\exp(-j2\beta L) = 1$$

[4-22]

## Threshold gain & current density

$$\Gamma g_{th} = \bar{\alpha} + \frac{1}{2L} \ln\left(\frac{1}{R_1 R_2}\right) \quad [4-23]$$

Laser starts to "lase" iff :  $g \geq g_{th}$

For laser structure with strong carrier confinement, the threshold current Density for stimulated emission can be well approximated by:

$$g_{th} = \beta J_{th} \quad [4-24]$$

$\beta$  : constant depends on specific device construction

# Optical output vs. drive current

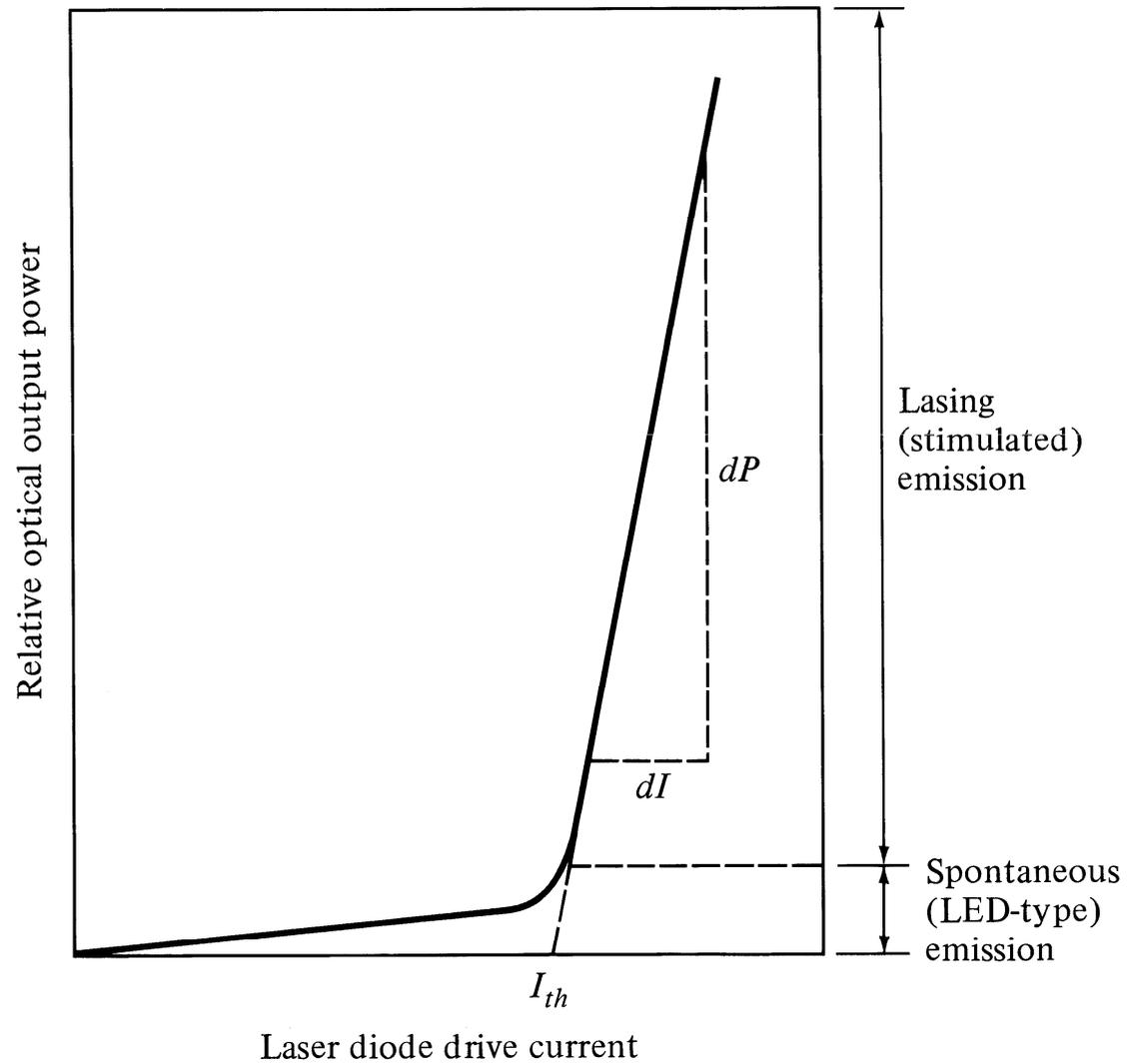

# Semiconductor laser rate equations

- Rate equations relate the optical output power, or # of photons per unit volume,  $\Phi$ , to the diode drive current or # of injected electrons per unit volume,  $n$ . For active (carrier confinement) region of depth  $d$ , the rate equations are:

$$\frac{d\Phi}{dt} = Cn\Phi + R_{sp} - \frac{\Phi}{\tau_{ph}}$$

Photon rate = stimulated emission + spontaneous emission + photon loss [4-25]

$$\frac{dn}{dt} = \frac{J}{qd} - \frac{n}{\tau_{sp}} - Cn\Phi$$

electron rate = injection + spontaneous recombination + stimulated emission

$C$  : Coefficient expressing the intensity of the optical emission & absorption process

$R_{sp}$  : rate of spontaneous emission into the lasing mode

$\tau_{ph}$  : photon life time

$J$  : Injection current density

## Threshold current Density & excess electron density

- At the threshold of lasing:  $\Phi \approx 0, d\Phi / dt \geq 0, R_{sp} \approx 0$

from eq. [4 - 25]  $\Rightarrow Cn\Phi - \Phi / \tau_{ph} \geq 0 \Rightarrow n \geq \frac{1}{C\tau_{ph}} = n_{th}$  [4-26]

- The threshold current needed to maintain a steady state threshold concentration of the excess electron, is found from electron rate equation under steady state condition  $dn/dt=0$  when the laser is just about to lase:

$$0 = \frac{J_{th}}{qd} - \frac{n_{th}}{\tau_{sp}} \Rightarrow J_{th} = qd \frac{n_{th}}{\tau_{sp}} \quad [4-27]$$

# Laser operation beyond the threshold

$$J > J_{th}$$

- The solution of the rate equations [4-25] gives the steady state photon density, resulting from stimulated emission and spontaneous emission as follows:

$$\Phi_s = \frac{\tau_{ph}}{qd} (J - J_{th}) + \tau_{ph} R_{sp}$$

[4-28]

# External quantum efficiency

- Number of photons emitted per radiative electron-hole pair recombination above threshold, gives us the external quantum efficiency.

$$\begin{aligned}\eta_{ext} &= \frac{\eta_i (g_{th} - \bar{\alpha})}{g_{th}} \\ &= \frac{q}{E_g} \frac{dP}{dI} = 0.8065 \lambda [\mu\text{m}] \frac{dP(\text{mW})}{dI(\text{mA})}\end{aligned}\quad [4-29]$$

- Note that:  $\eta_i \approx 60\% - 70\%$ ;  $\eta_{ext} \approx 15\% - 40\%$

# Laser Resonant Frequencies

- Lasing condition, namely eq. [4-22]:

$$\exp(-j2\beta L) = 1 \Rightarrow 2\beta L = 2m\pi, \quad m = 1, 2, 3, \dots$$

- Assuming  $\beta = \frac{2\pi n}{\lambda}$  the resonant frequency of the  $m$ th mode is:

$$\nu_m = \frac{mc}{2Ln} \quad m = 1, 2, 3, \dots \quad [4-30]$$

$$\Delta\nu = \nu_m - \nu_{m-1} = \frac{c}{2Ln} \Leftrightarrow \Delta\lambda = \frac{\lambda^2}{2Ln} \quad [4-31]$$

# Spectrum from a Laser Diode

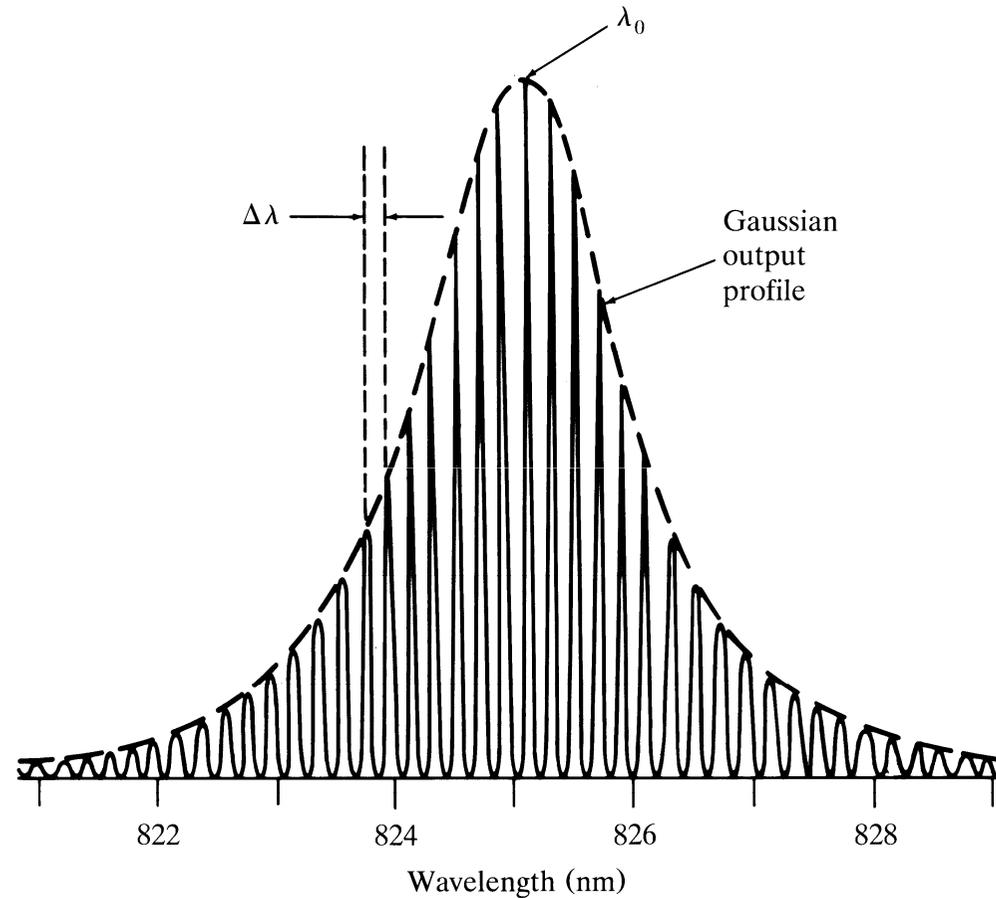

$$g(\lambda) = g(0) \exp\left[-\frac{(\lambda - \lambda_0)^2}{2\sigma^2}\right] \quad \sigma : \text{spectral width}$$

[4-32]

# Laser Diode Structure & Radiation Pattern

- Efficient operation of a laser diode requires reducing the # of lateral modes, stabilizing the gain for lateral modes as well as lowering the threshold current. These are met by structures that confine the optical wave, carrier concentration and current flow in the lateral direction. The important types of laser diodes are: **gain-induced, positive index guided, and negative index guided.**

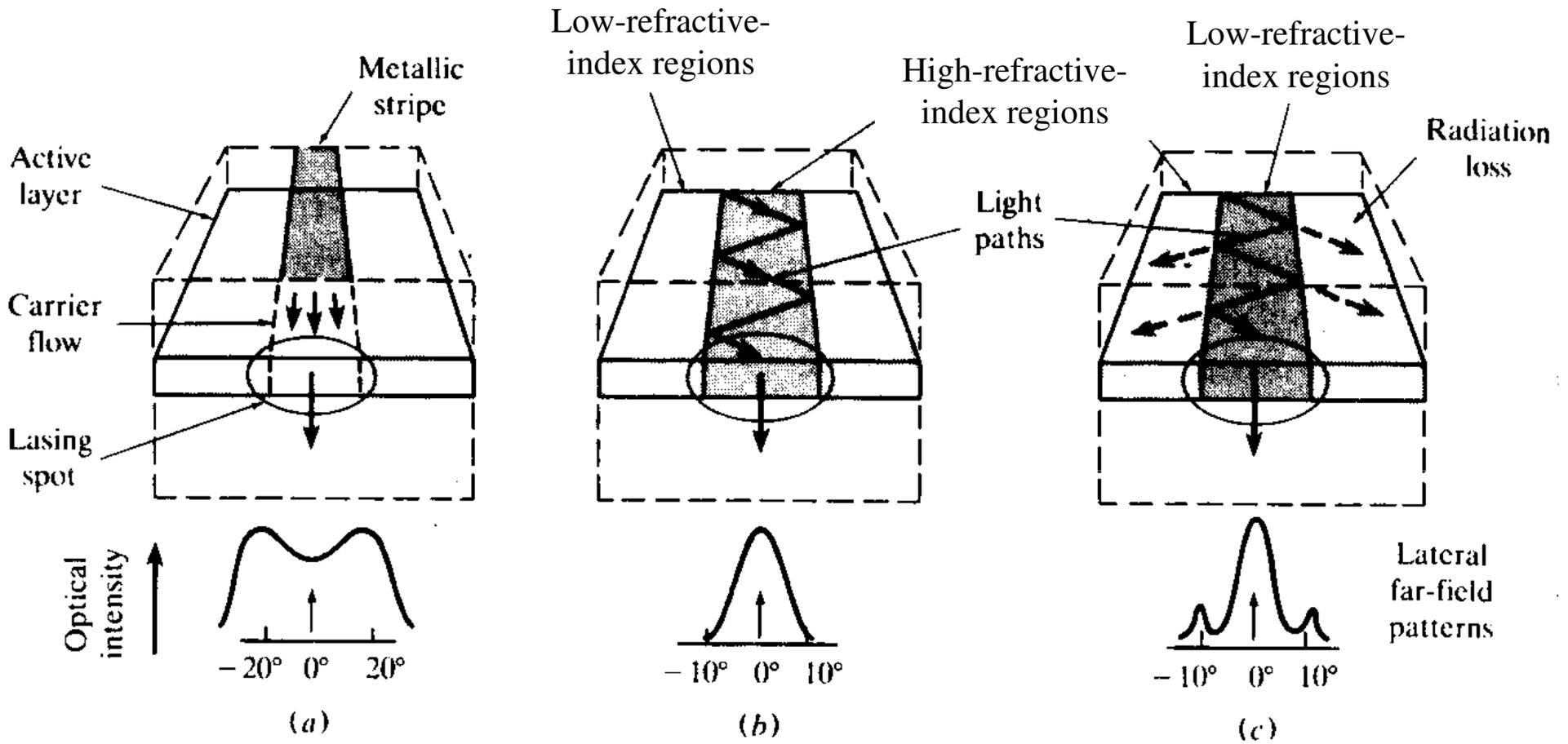

(a) gain-induced guide    (b) positive-index waveguide    (c) negative-index waveguide

Unstable, two-peaked beam

Can made single-mode laser

## Laser Diode with buried heterostructure (BH)

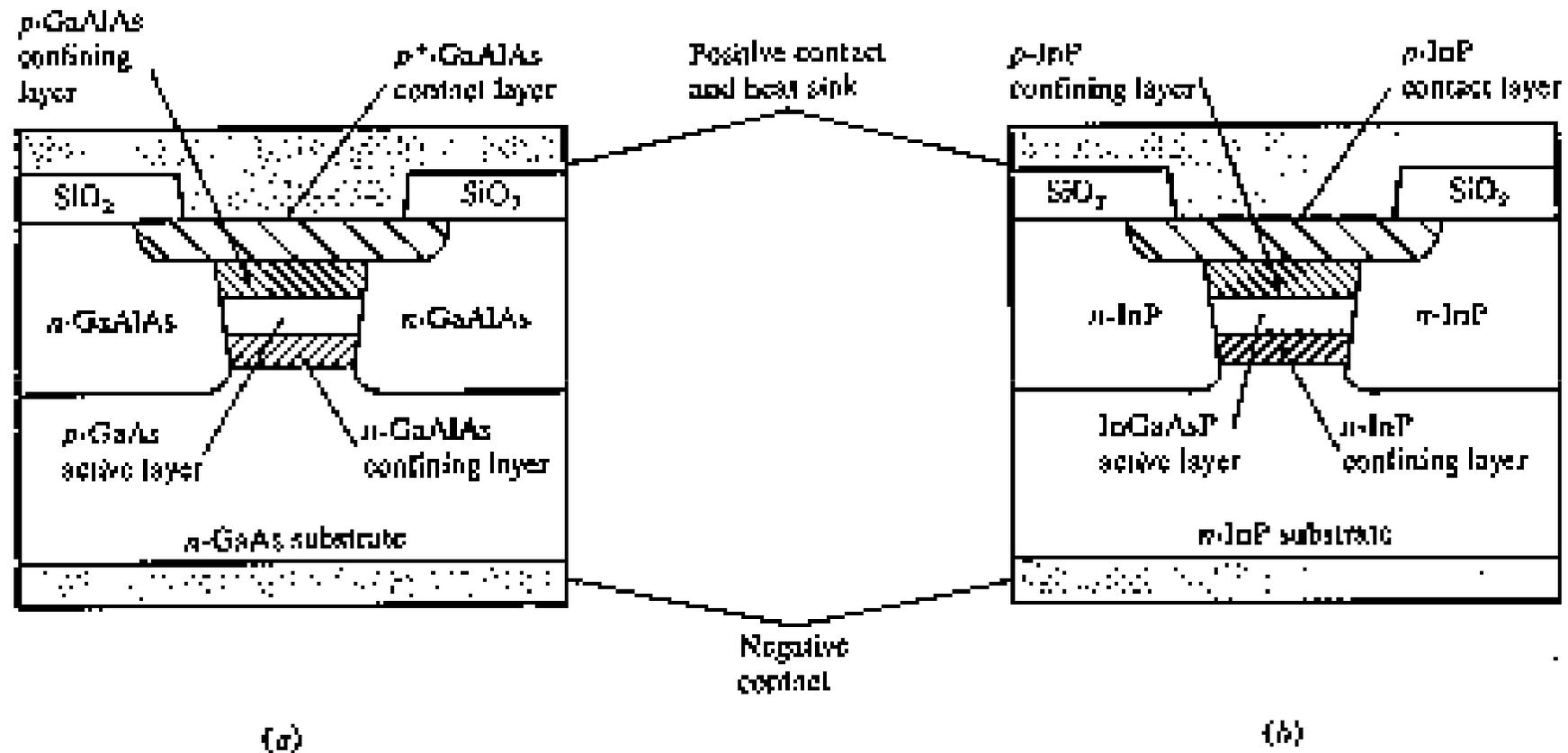
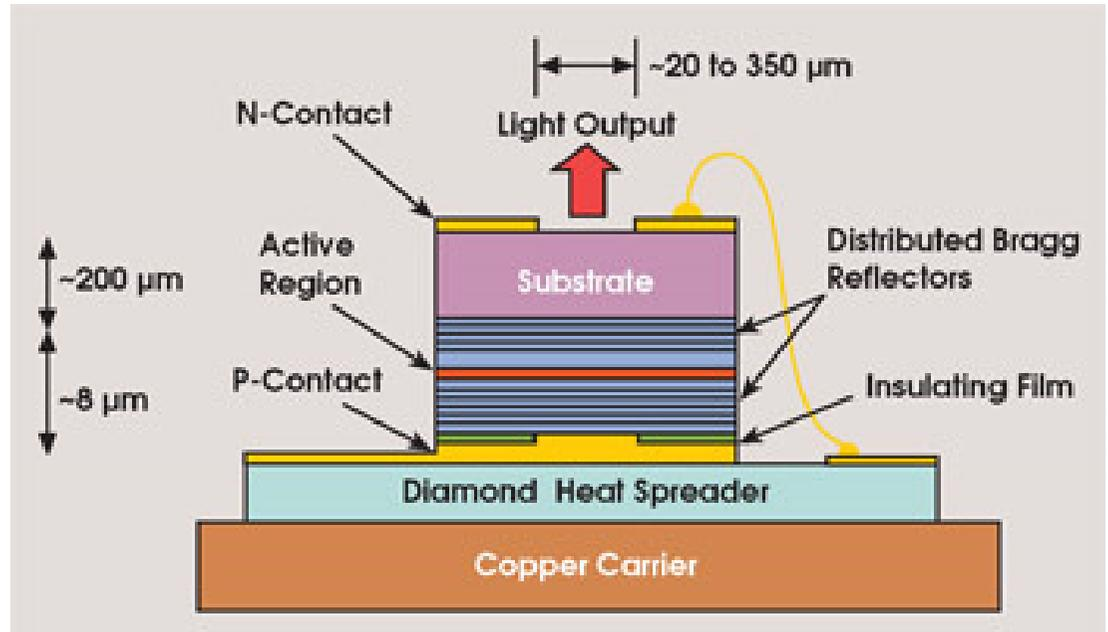
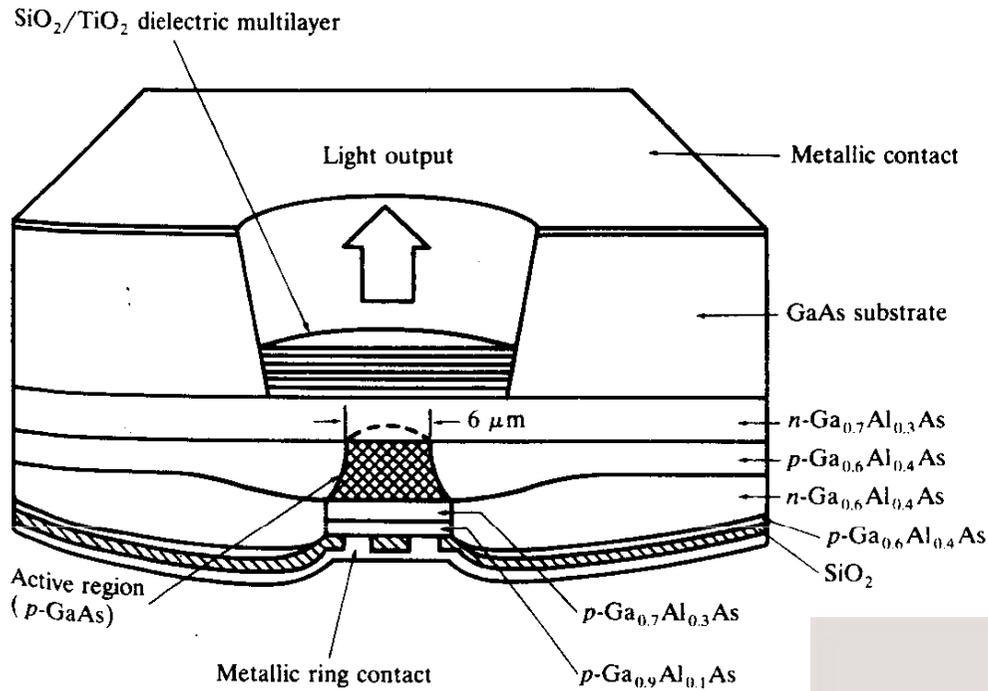

FIGURE 4-23  
 (a) Short-wavelength (800-900 nm) GaAlAs and (b) long-wavelengths (1300-1600 nm) InGaAsP buried-heterostructure laser diodes.

# Single Mode Laser

- Single mode laser is mostly based on the index-guided structure that supports only the fundamental transverse mode and the fundamental longitudinal mode. In order to make single mode laser we have four options:
  - 1- Reducing the length of the cavity to the point where the frequency separation given in eq[4-31] of the adjacent modes is larger than the laser transition line width. This is hard to handle for fabrication and results in low output power.
  - 2- **Vertical-Cavity Surface Emitting laser (VCSEL)**
  - 3- Structures with built-in frequency selective grating
  - 4- tunable laser diodes

# VCSEL



## Frequency-Selective Laser Diodes: Distributed Feedback (DFB) Laser

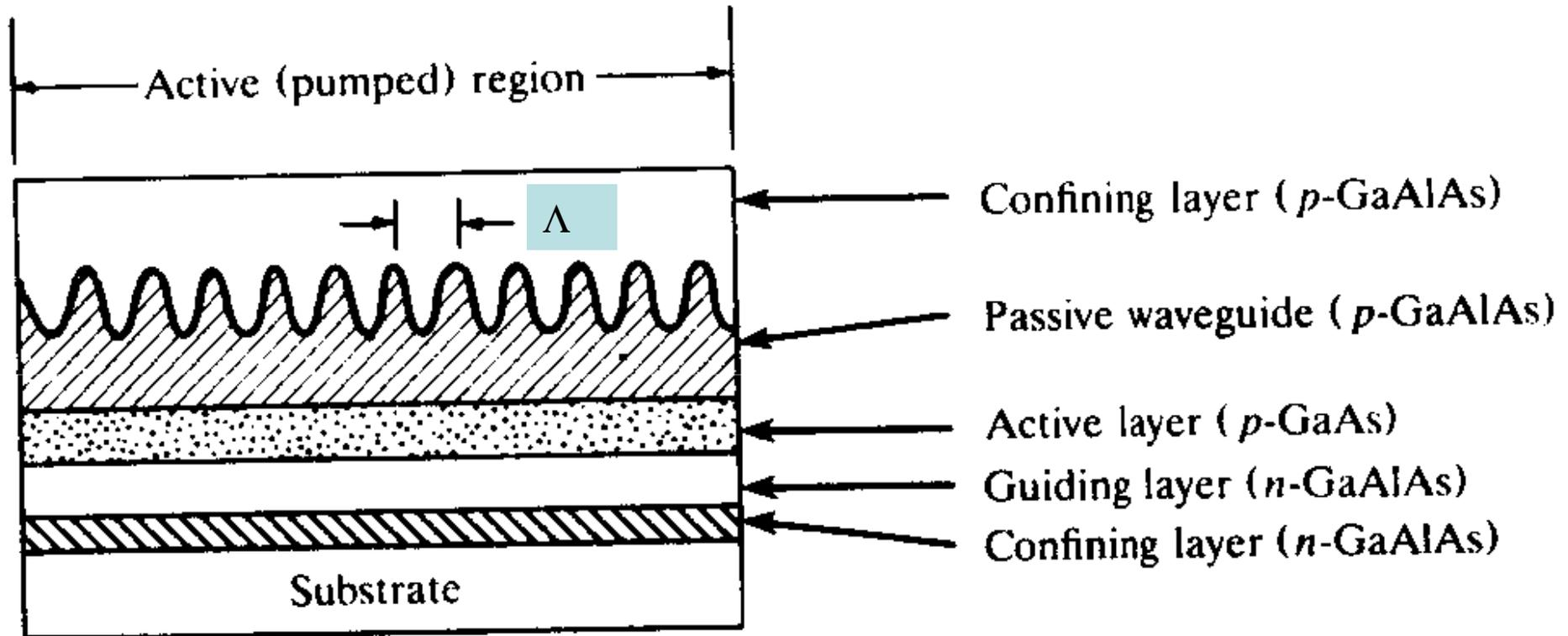

Bragg wavelength  $\lambda_B = \frac{2n_e \Lambda}{m}$

[4-33]

$\lambda_B$  : effective refractive index;  $m$  : order of the grating

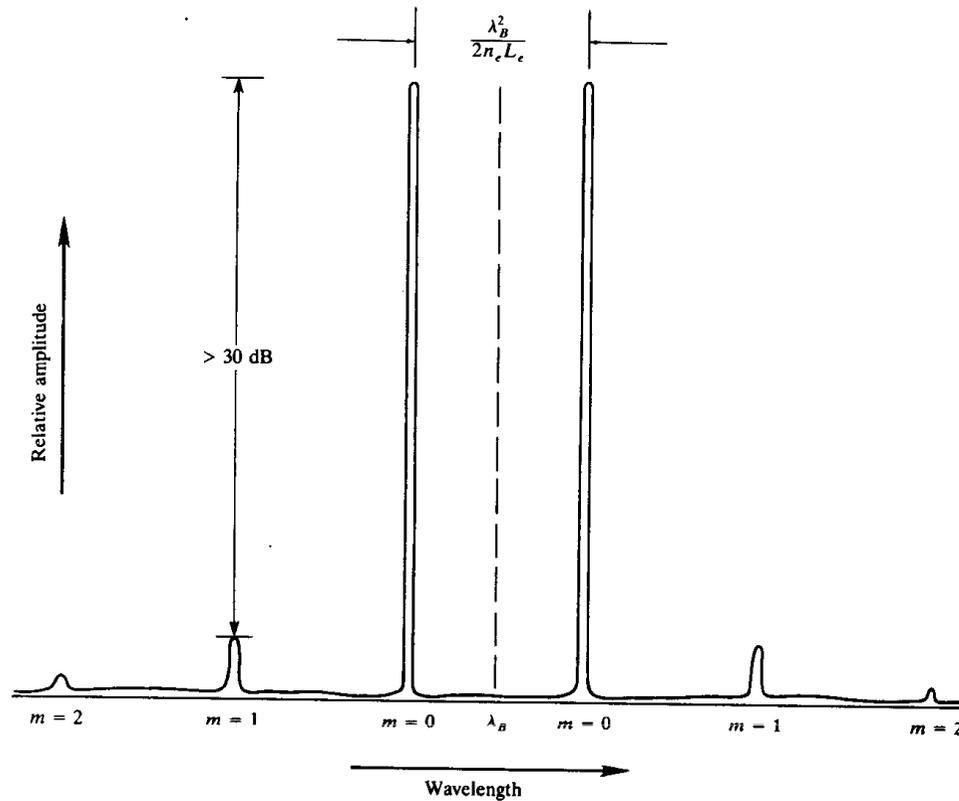

Output spectrum symmetrically distributed around Bragg wavelength in an idealized DFB laser diode

$$\lambda = \lambda_B \pm \frac{\lambda_B^2}{2n_e L_e} \left(m + \frac{1}{2}\right) \quad [4-35]$$

$L_e$  : effective grating length;  
 $m (=0,1,2)$  : mode order

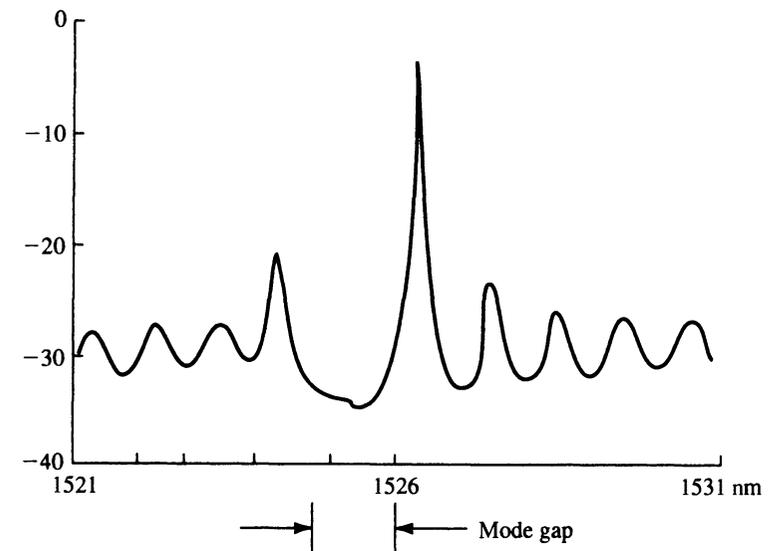
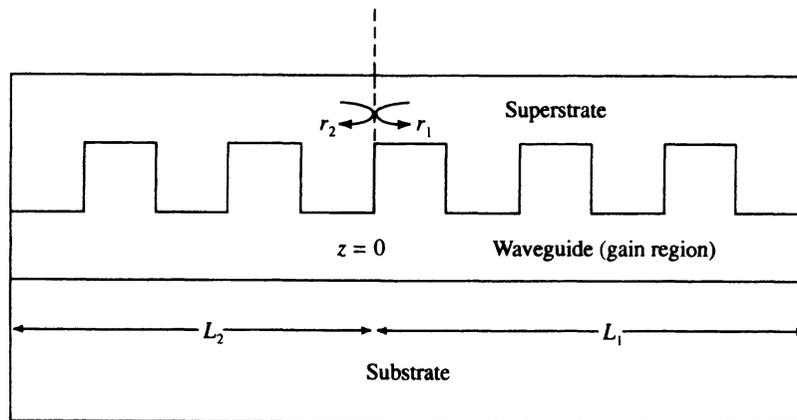

# Frequency-Selective laser Diodes: Distributed Feedback Reflector (DBR) laser

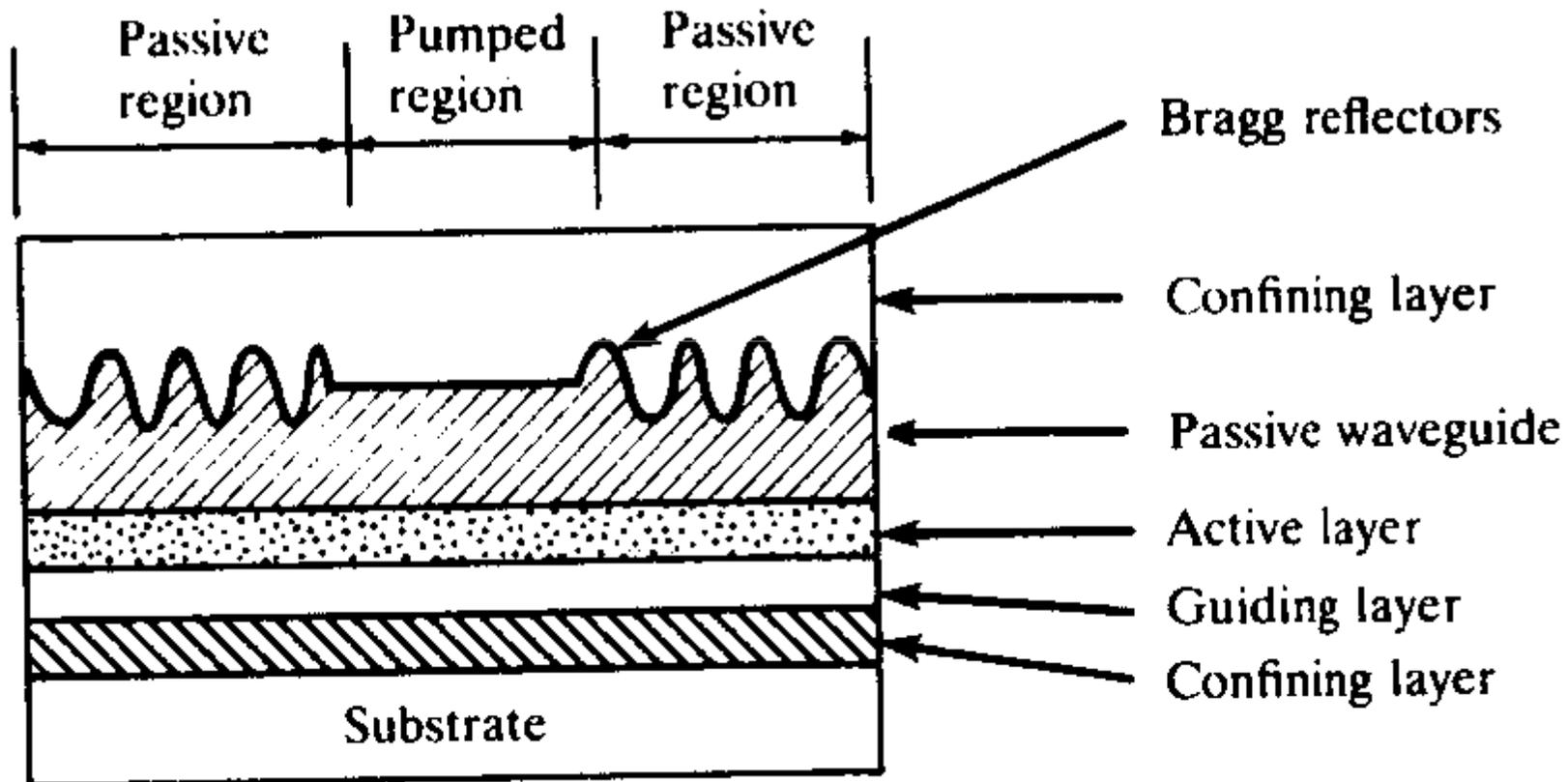

# Frequency-Selective Laser Diodes: Distributed Reflector (DR) Laser

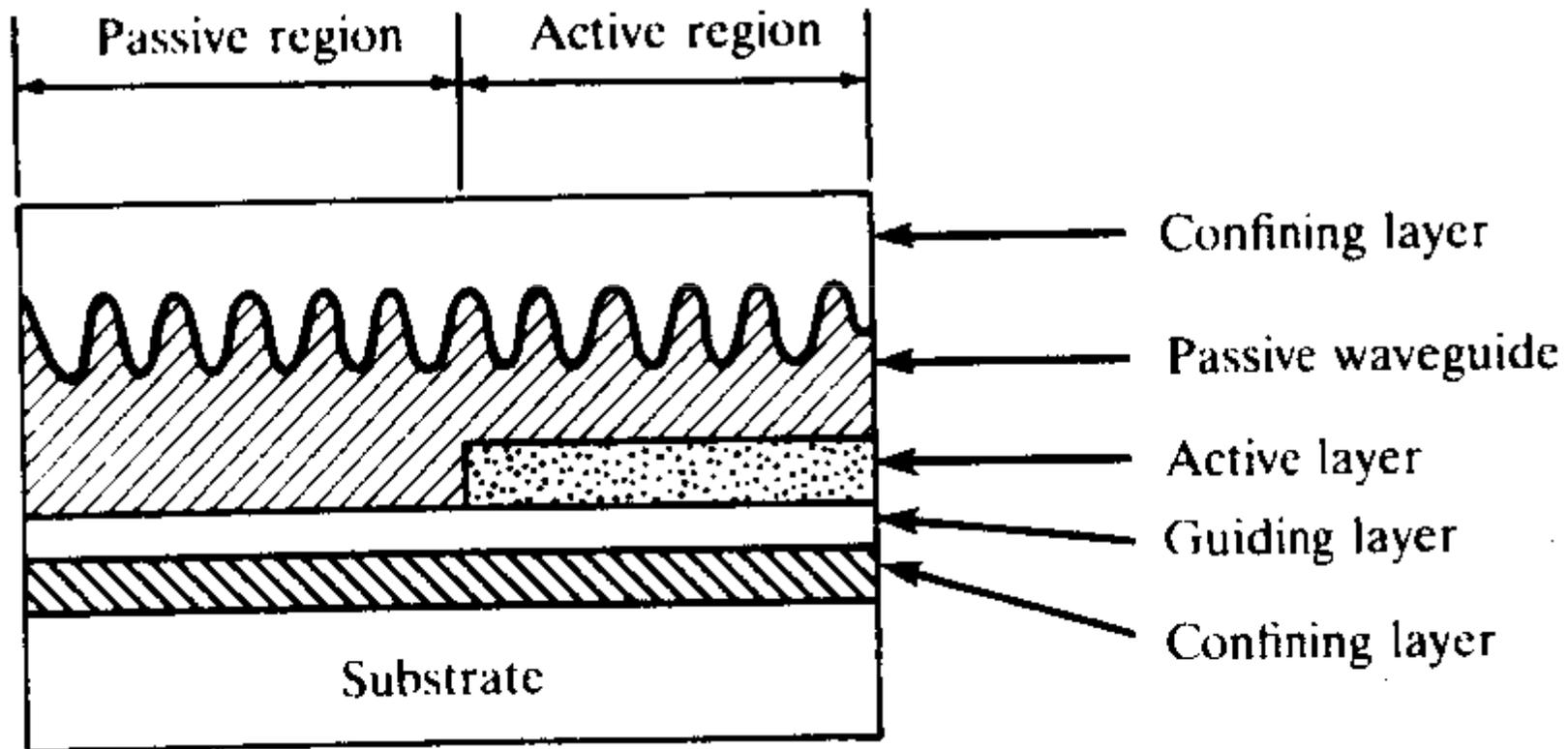

## Modulation of Laser Diodes

- Internal Modulation: Simple but suffers from non-linear effects.
- External Modulation: for rates greater than 2 Gb/s, more complex, higher performance.
- Most fundamental limit for the modulation rate is set by the photon life time in the laser cavity:

$$\frac{1}{\tau_{ph}} = \frac{c}{n} \left( \bar{\alpha} + \frac{1}{2L} \ln \frac{1}{R_1 R_2} \right) = \frac{c}{n} g_{th} \quad [4-36]$$

- Another fundamental limit on modulation frequency is the relaxation oscillation frequency given by:

$$f = \frac{1}{2\pi} \frac{1}{\sqrt{\tau_{sp} \tau_{ph}}} \left( \frac{I}{I_{th}} - 1 \right)^{1/2} \quad [4-37]$$

# Relaxation oscillation peak

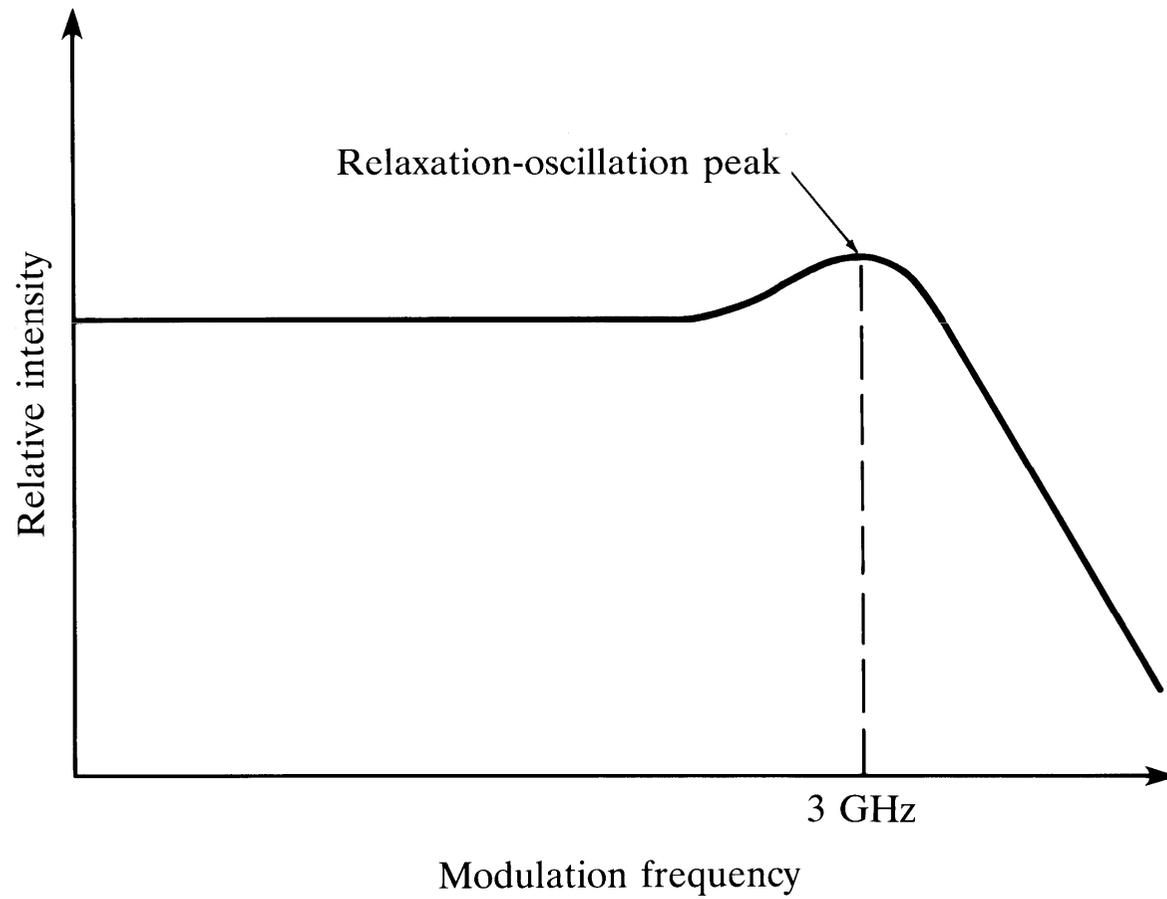

# Pulse Modulated laser

- In a pulse modulated laser, if the laser is completely turned off after each pulse, after onset of the current pulse, a time delay,  $t_d$ , given by:

$$t_d = \tau \ln \left[ \frac{I_p}{I_p + (I_B - I_{th})} \right] \quad [4-38]$$

$\tau$  : carrier life time

$I_p$  : Current pulse amplitude

$I_B$  : Bias current

# Linearity of Laser

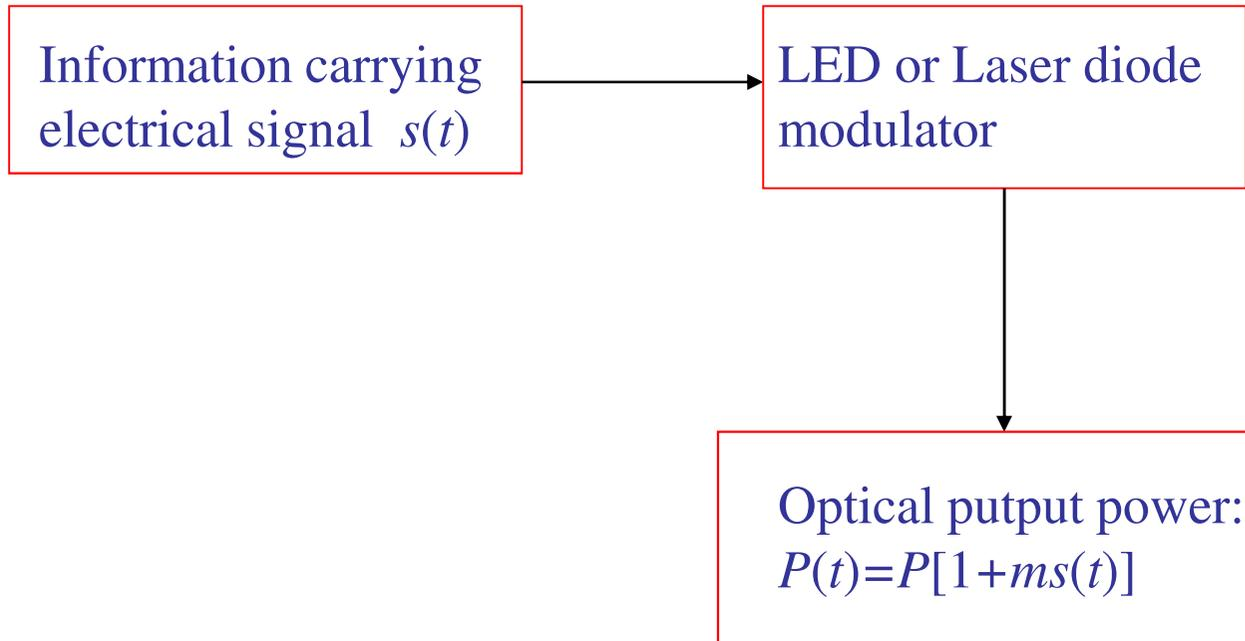

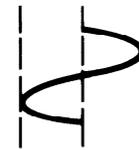
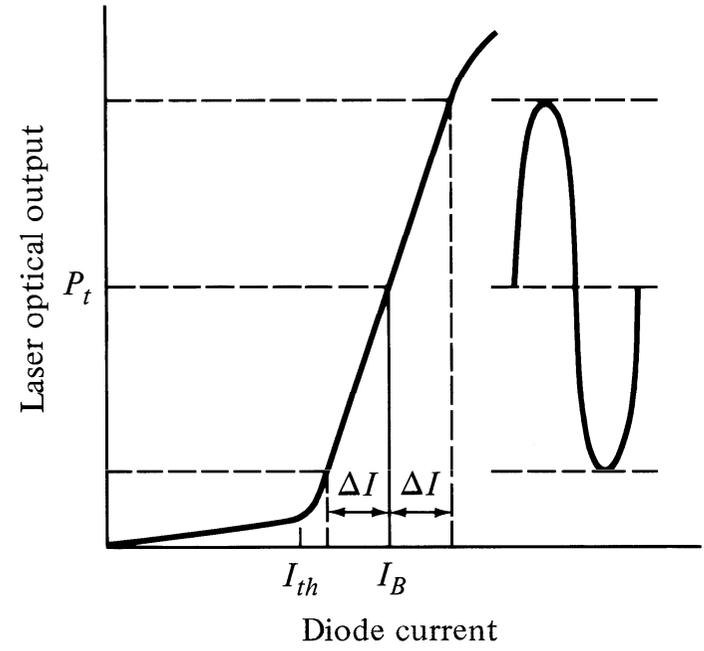
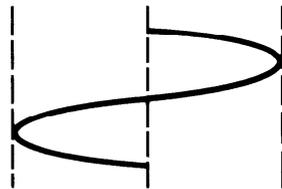
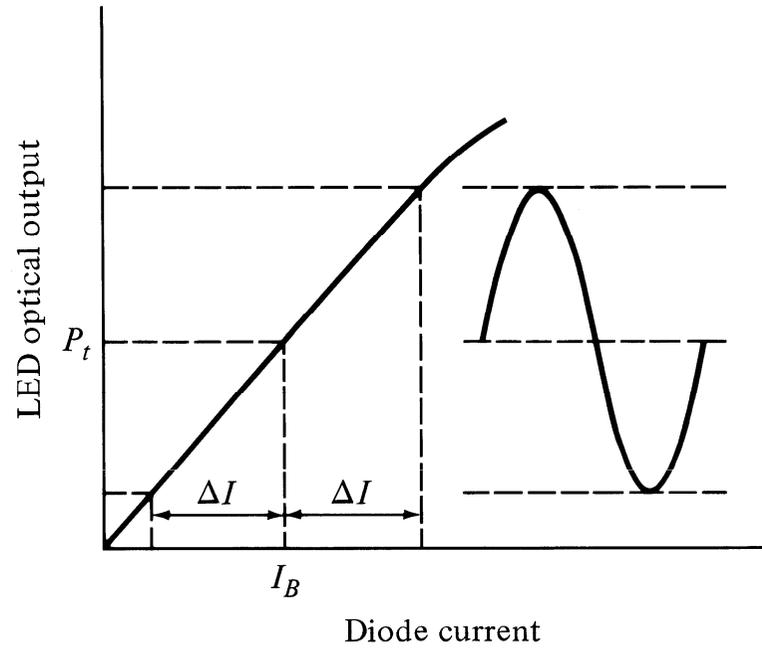

# Nonlinearity



$$x(t) = A \cos \omega t$$

$$y(t) = A_0 + A_1 \cos \omega t + A_2 \cos 2\omega t + \dots$$

$N^{\text{th}}$  order harmonic distortion:

$$20 \log \left( \frac{A_n}{A_1} \right)$$

# Intermodulation Distortion

$$x(t) = A_1 \cos \omega_1 t + A_2 \cos \omega_2 t \Rightarrow$$

$$y(t) = \sum_{m,n} B_{mn} \cos(m\omega_1 + n\omega_2)t \quad m,n = 0, \pm 1, \pm 2, \dots$$

Harmonics:

$$n \omega_1, m \omega_2$$

Intermodulated Terms:

$$\omega_1 \pm \omega_2, 2\omega_1 \pm \omega_2, \omega_1 \pm 2\omega_2, \dots$$

# Laser Noise

- **Modal (speckle) Noise:** Fluctuations in the distribution of energy among various modes.
- **Mode partition Noise:** Intensity fluctuations in the longitudinal modes of a laser diode, main source of noise in single mode fiber systems.
- **Reflection Noise:** Light output gets reflected back from the fiber joints into the laser, couples with lasing modes, changing their phase, and generate noise peaks. Isolators & index matching fluids can eliminate these reflections.

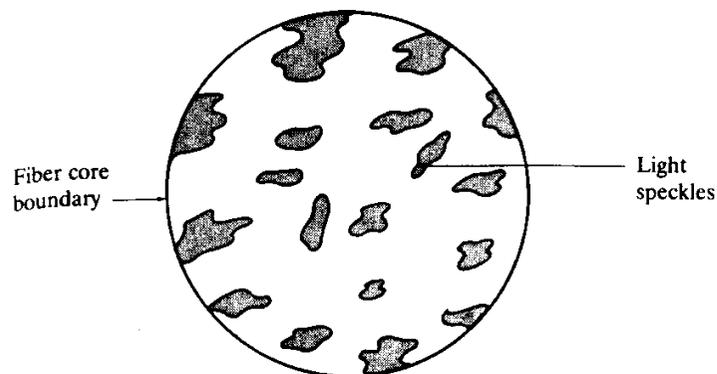

**A speckle pattern**

# Intensity Fluctuation

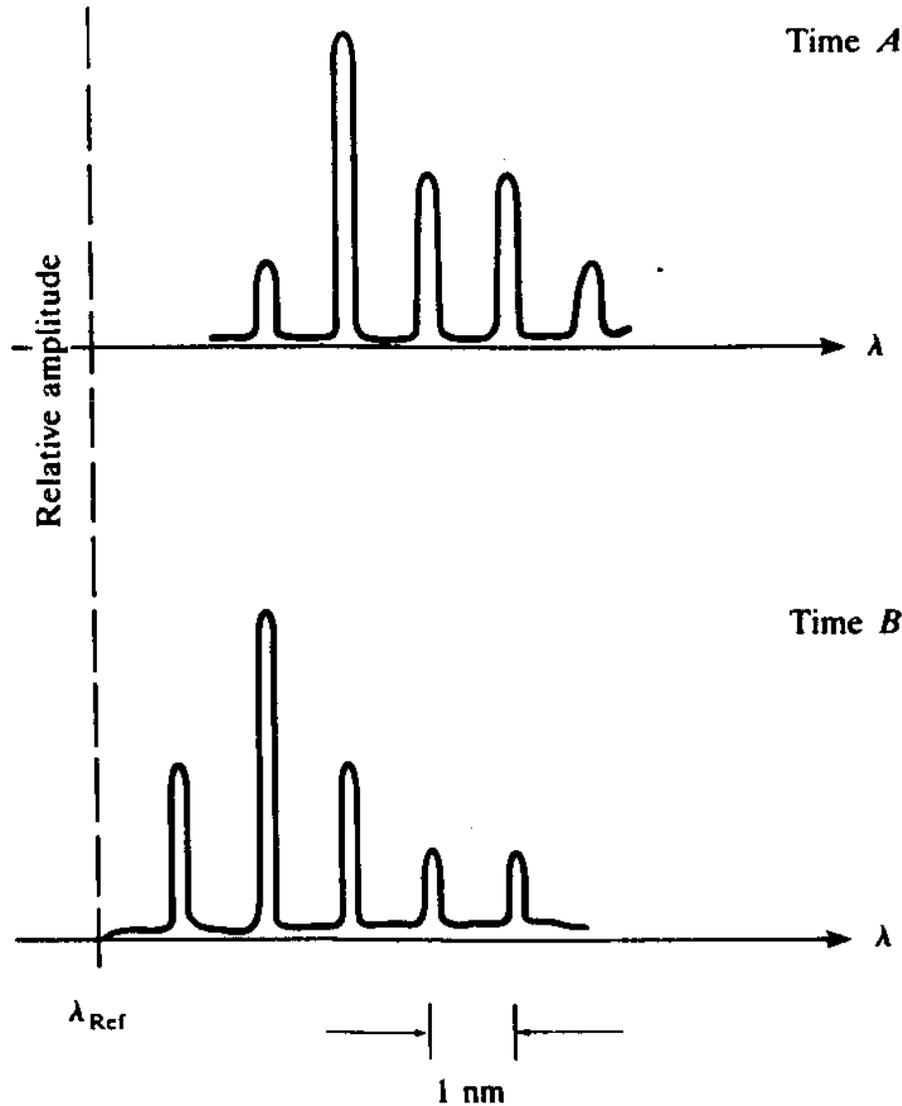

Different modes or groups of modes dominate the optical output at different times.

# Modulation of Optical Sources

- Optical sources can be modulated either **directly** or **externally**.
- Direct modulation is done by modulating the driving current according to the message signal (**digital or analog**)
- In external modulation, the laser emits **continuous wave** (CW) light and the modulation is done in the fiber

# Why Modulation

- A communication link is established by transmission of information reliably
- Optical modulation is embedding the information on the optical carrier for this purpose
- The information can be digital (1,0) or analog (a continuous waveform)
- The bit error rate (BER) is the performance measure in digital systems
- The signal to noise ratio (SNR) is the performance measure in analog systems

# Parameters to characterize performance of optical modulation

- modulation depth
- bandwidth
- insertion loss
- degree of isolation
- power handling
- induced chirp

# Important parameters used to characterize and compare different modulators

- ***Modulation efficiency***: Defined differently depending on if we modulate intensity, phase or frequency. For intensity it is defined as  $(I_{\max} - I_{\min})/I_{\max}$ .
- ***Modulation depth***: For intensity modulation it is defined in decibel by  $10 \log (I_{\max}/I_{\min})$ .
- ***Modulation bandwidth***: Defined as the high frequency at which the efficiency has fallen by 3dB.
- ***Power consumption***: Simply the power consumption per unit bandwidth needed for (intensity) modulation.

# Types of Optical Modulation

- Direct modulation is done by superimposing the modulating (message) signal on the driving current
- External modulation is done after the light is *generated*; the laser is driven by a dc current and the modulation is done after that separately
- Both these schemes can be done with either *digital* or *analog* modulating signals

- Direct modulation of semiconductor lasers
  - frequency response
  - relaxation oscillation
  - chirp
- external modulators:
  - Electro-absorption modulators
  - Mach-Zehnder interferometer
- New mechanisms for laser-diode modulation
- Short-pulse techniques

# Direct Modulation

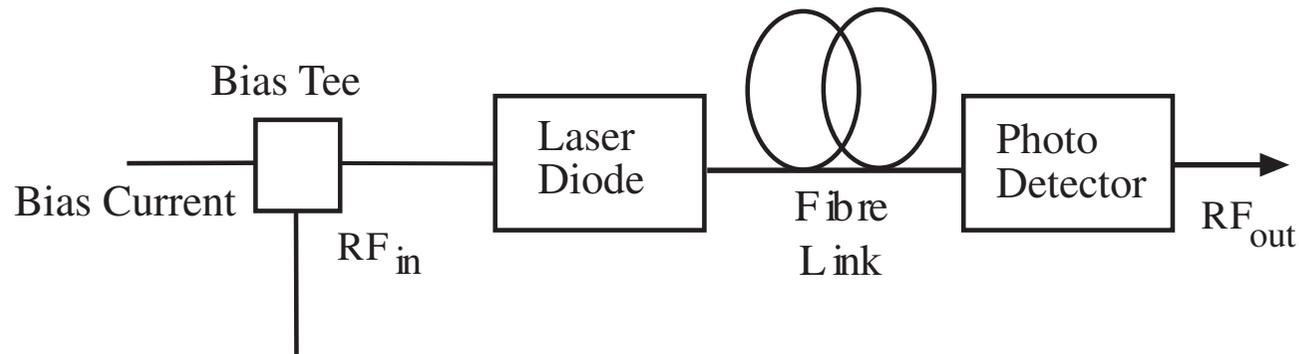

- The message signal (ac) is superimposed on the bias current (dc) which modulates the laser
- Robust and simple, hence widely used
- **Issues:** laser resonance frequency, chirp, turn on delay, clipping and laser nonlinearity

# Optical Output vs. Drive Current of a Laser

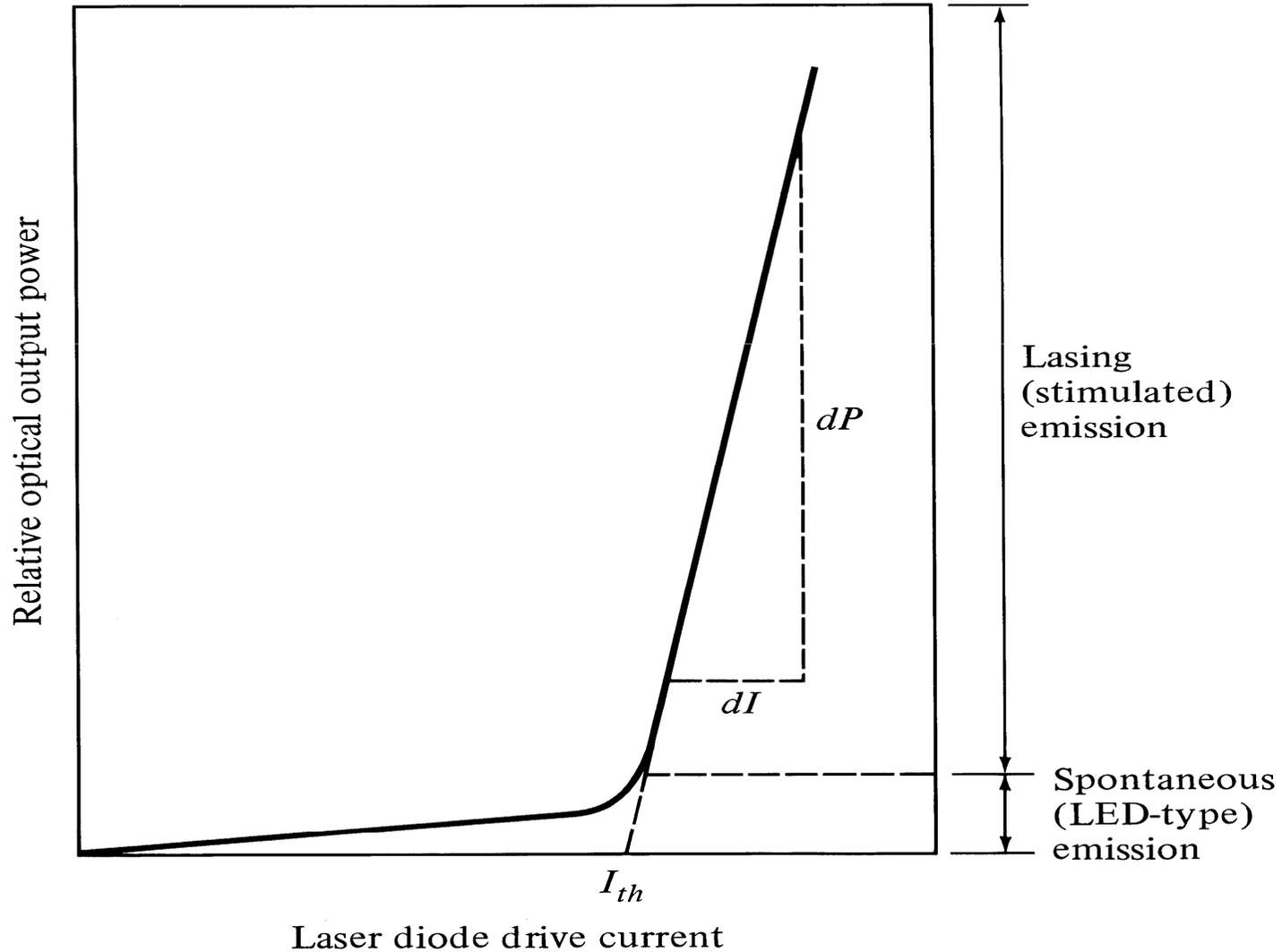

# Direct Analog Modulation

**LED**

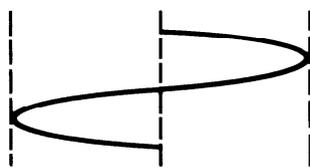
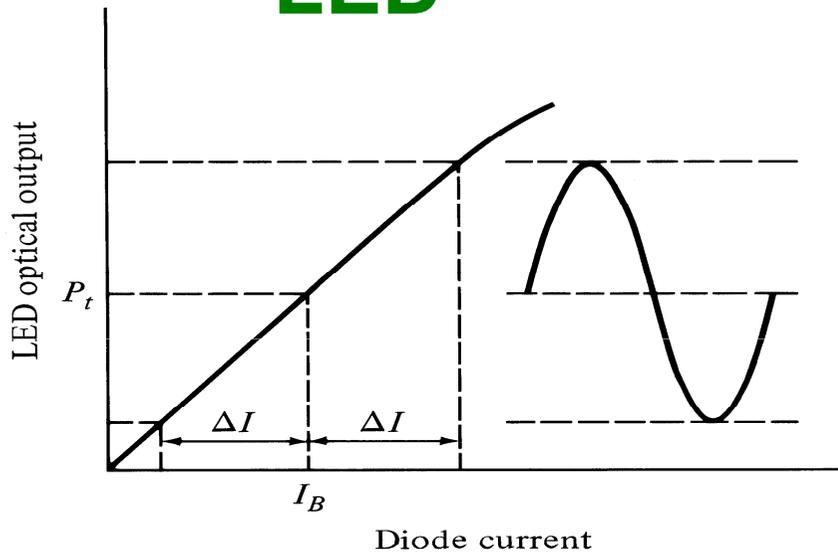

$$I'_B = I_B$$

Modulation index (depth)

**LASER**

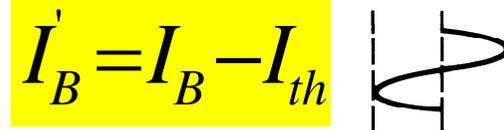
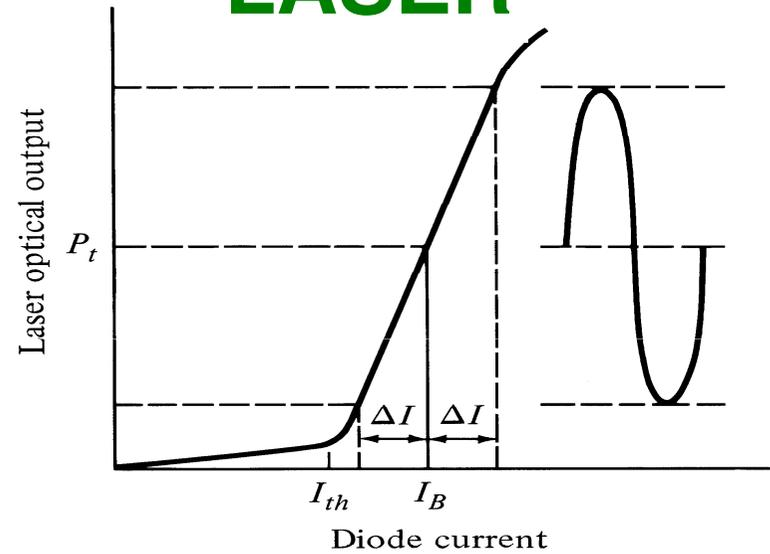

$$I'_B = I_B - I_{th}$$

$$m = \Delta I / I'_B$$

# Analog LED Modulation

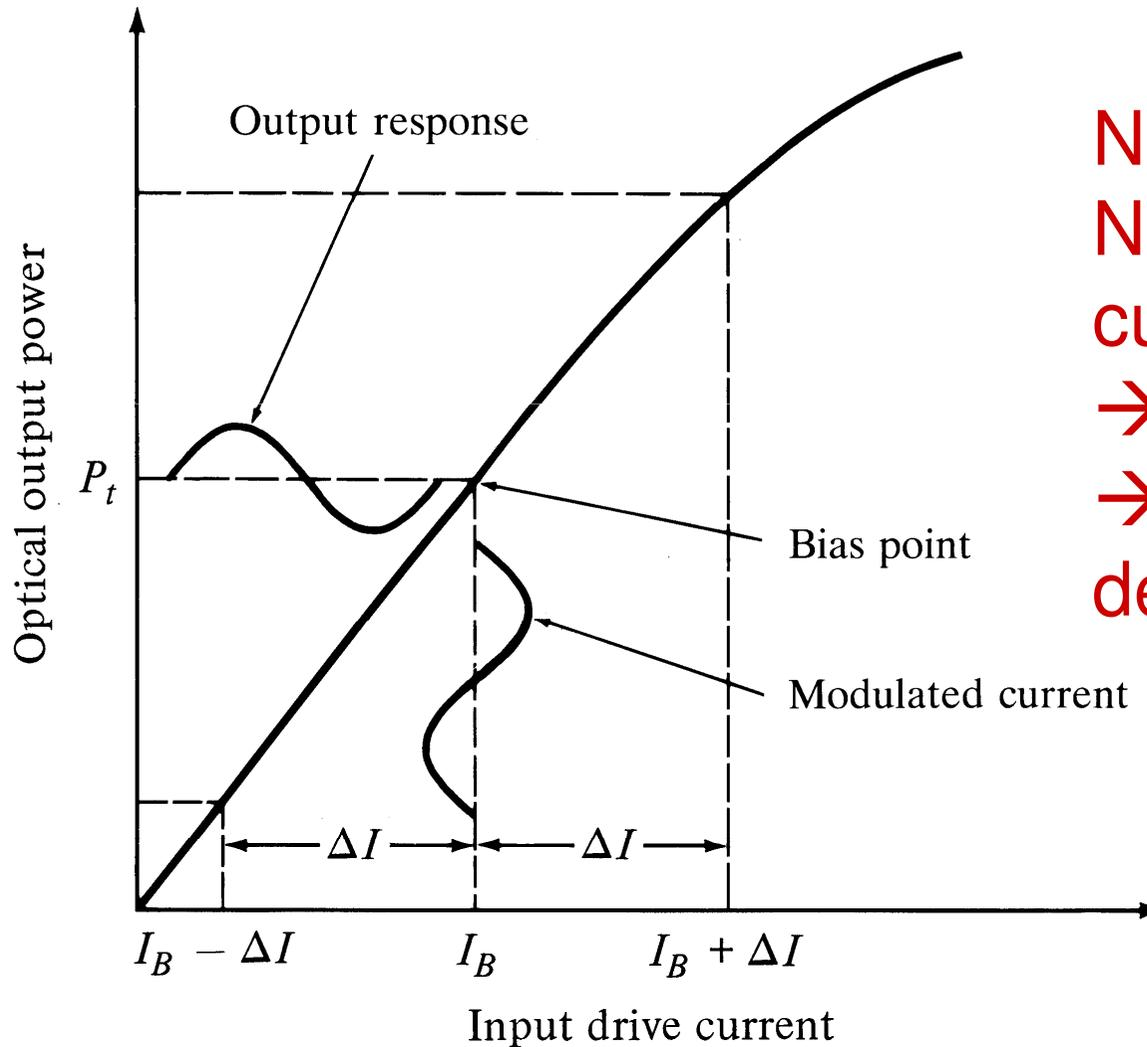

Note:  
No threshold current  
→ No clipping  
→ No turn on delay

# Laser Digital Modulation

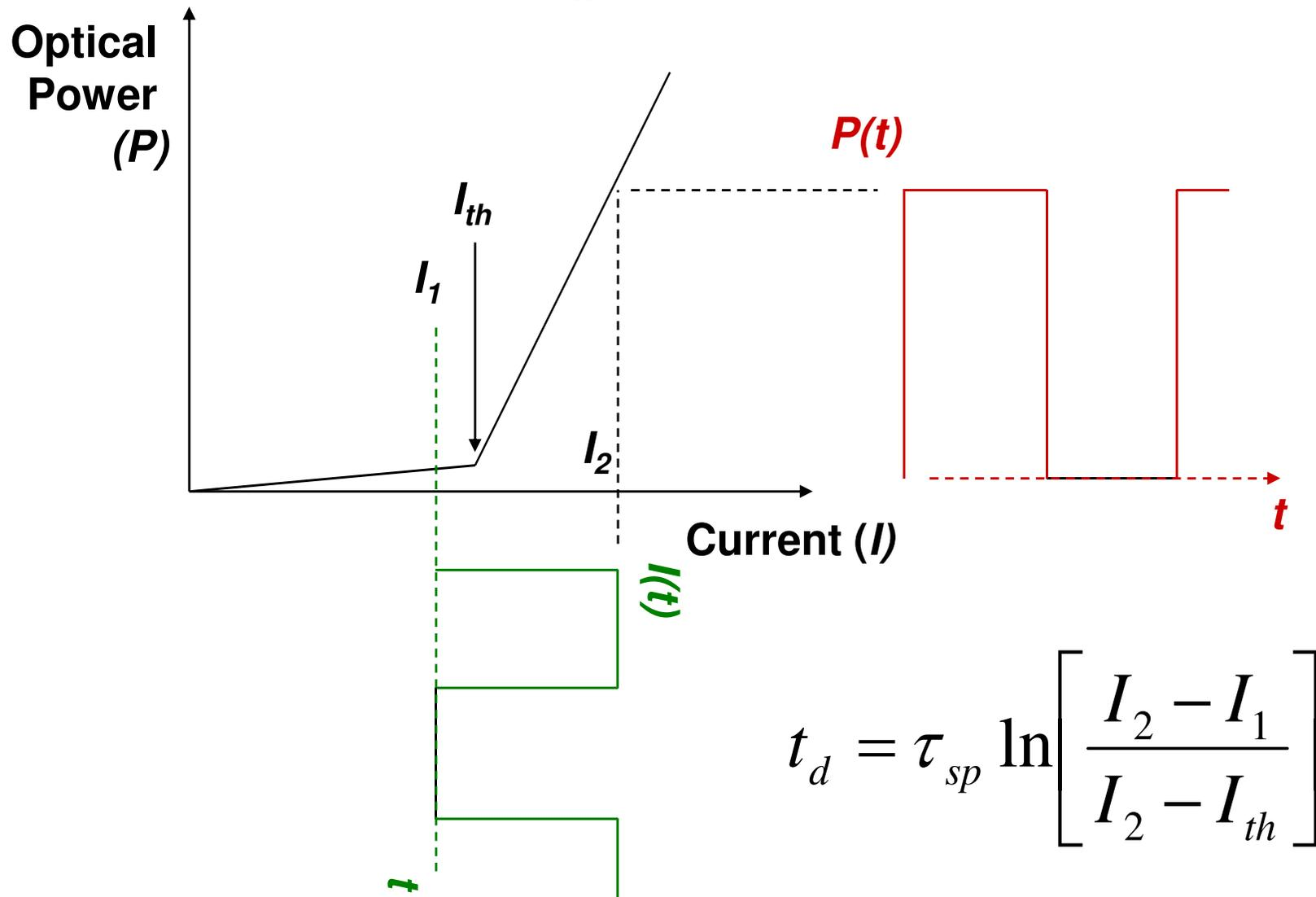

# Turn on Delay (lasers)

- When the driving current suddenly jumps from low ( $I_1 < I_{th}$ ) to high ( $I_2 > I_{th}$ ), (step input), there is a finite time before the laser will turn on
- This delay limits bit rate in *digital systems*
- Can you think of any solution?

$$t_d = \tau_{sp} \ln \left[ \frac{I_2 - I_1}{I_2 - I_{th}} \right]$$

- Input current
  - Assume step input

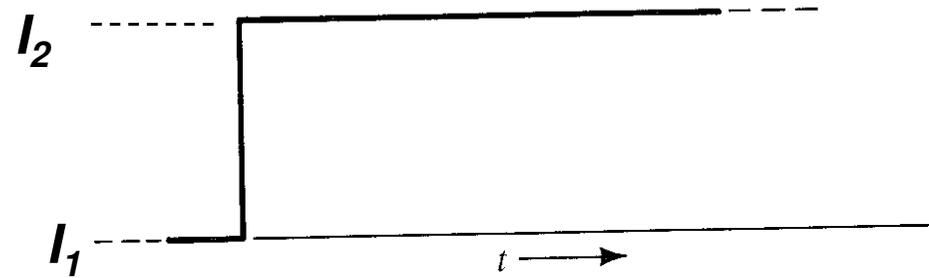

(a)

- Electron density
  - steadily increases until threshold value is reached

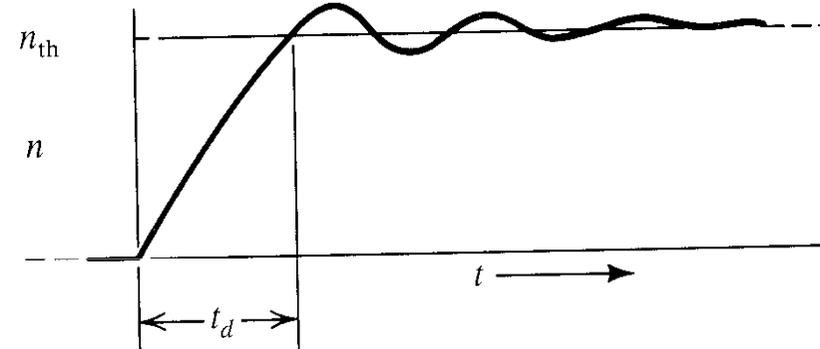

- Output optical power
  - Starts to increase only after the electrons reach the threshold

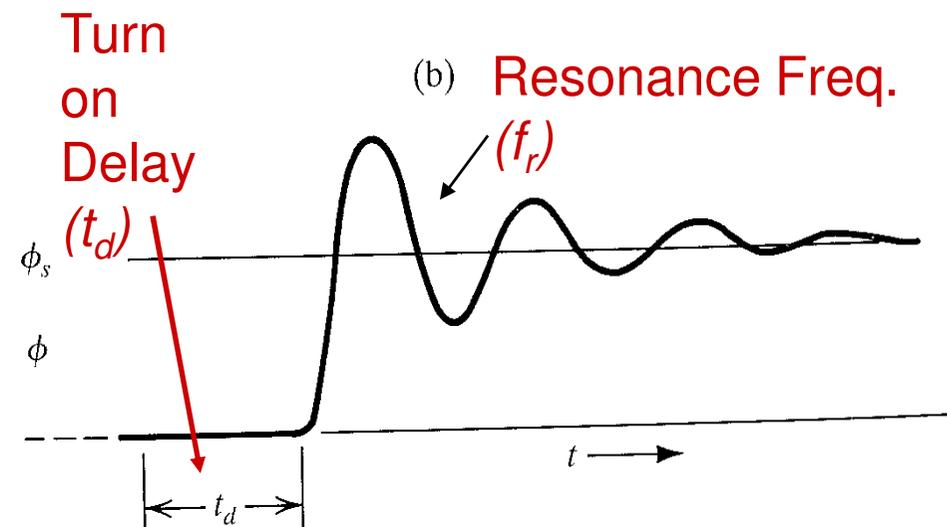

(c)

# Frequency Response of a Laser

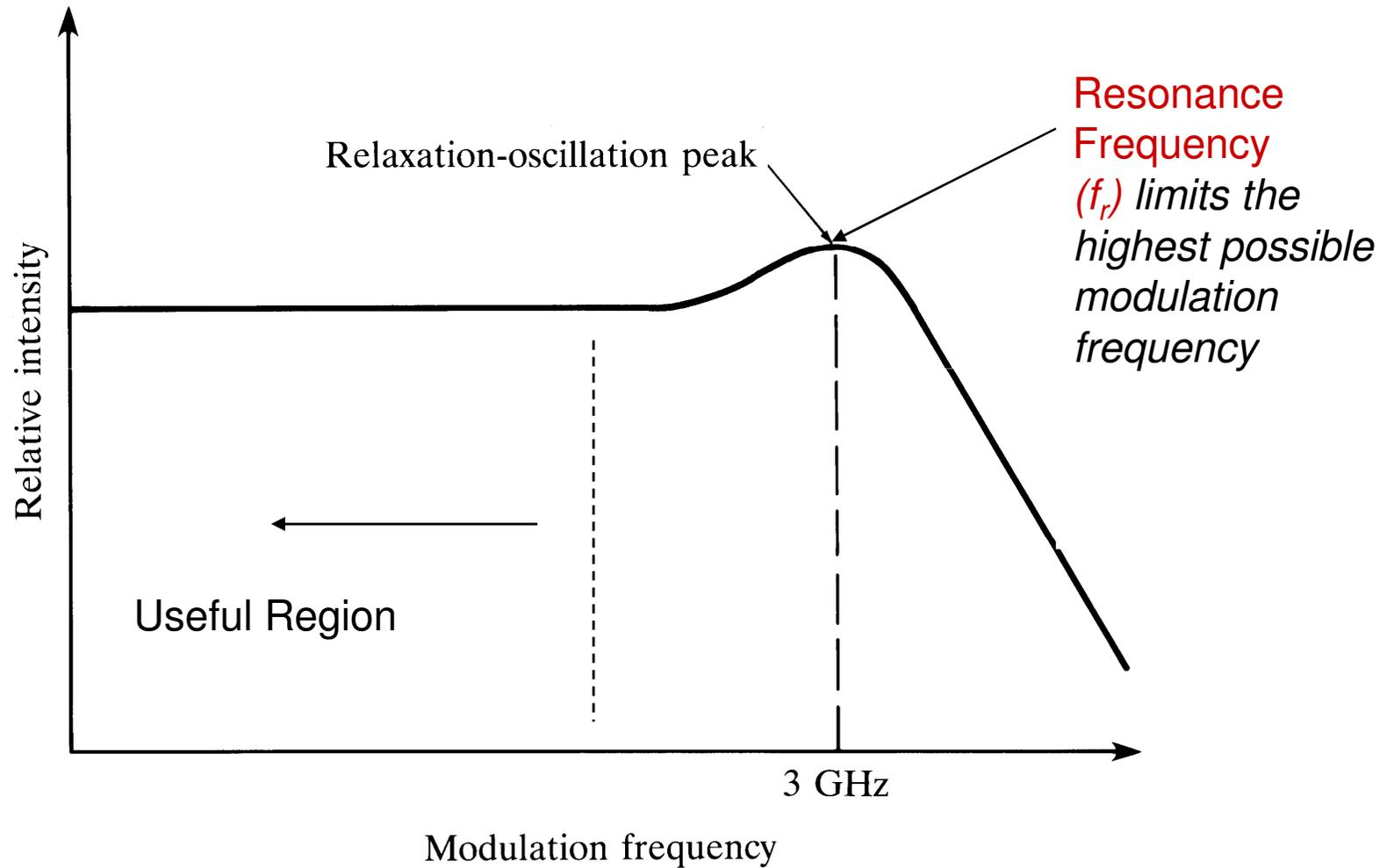

# Laser Analog Modulation

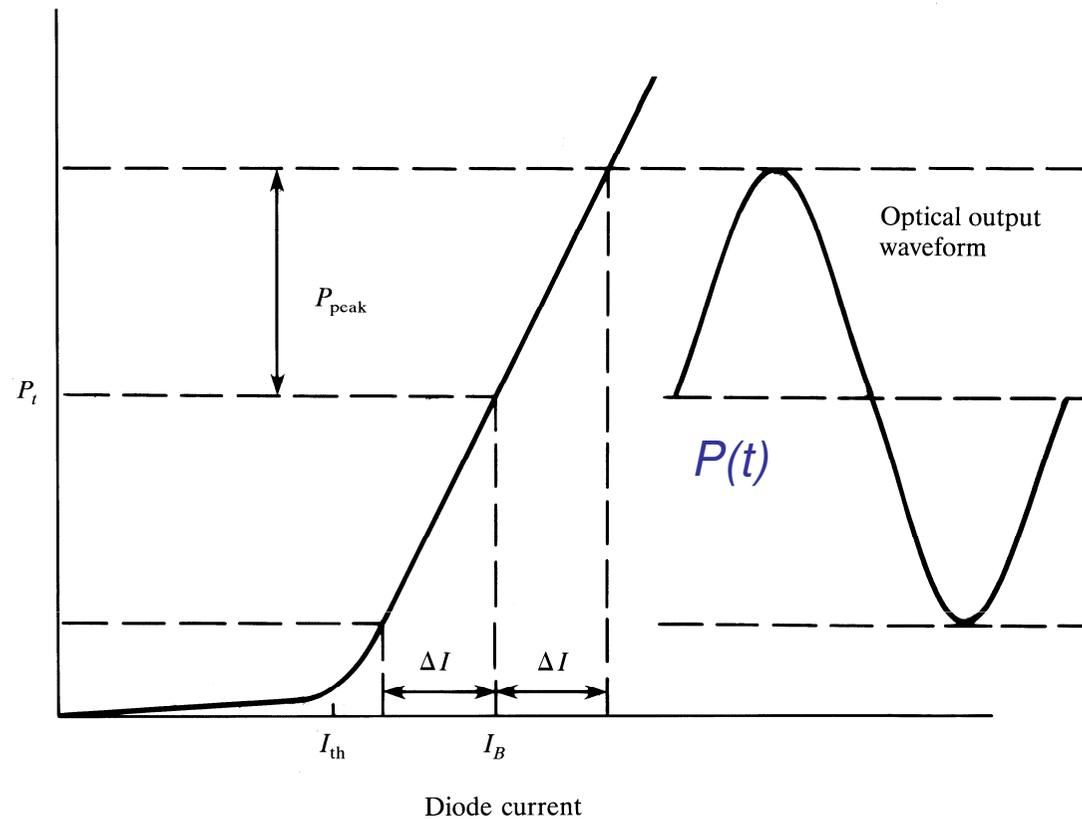

$$P(t) = P_t [1 + m s(t)]$$

Here  $s(t)$  is the modulating signal,  
 $P(t)$ : output optical power  
 $P_t$ : mean value

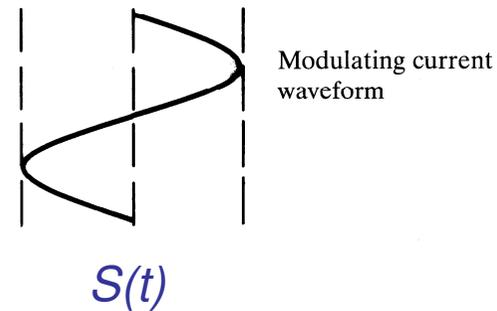

# The modulated spectrum

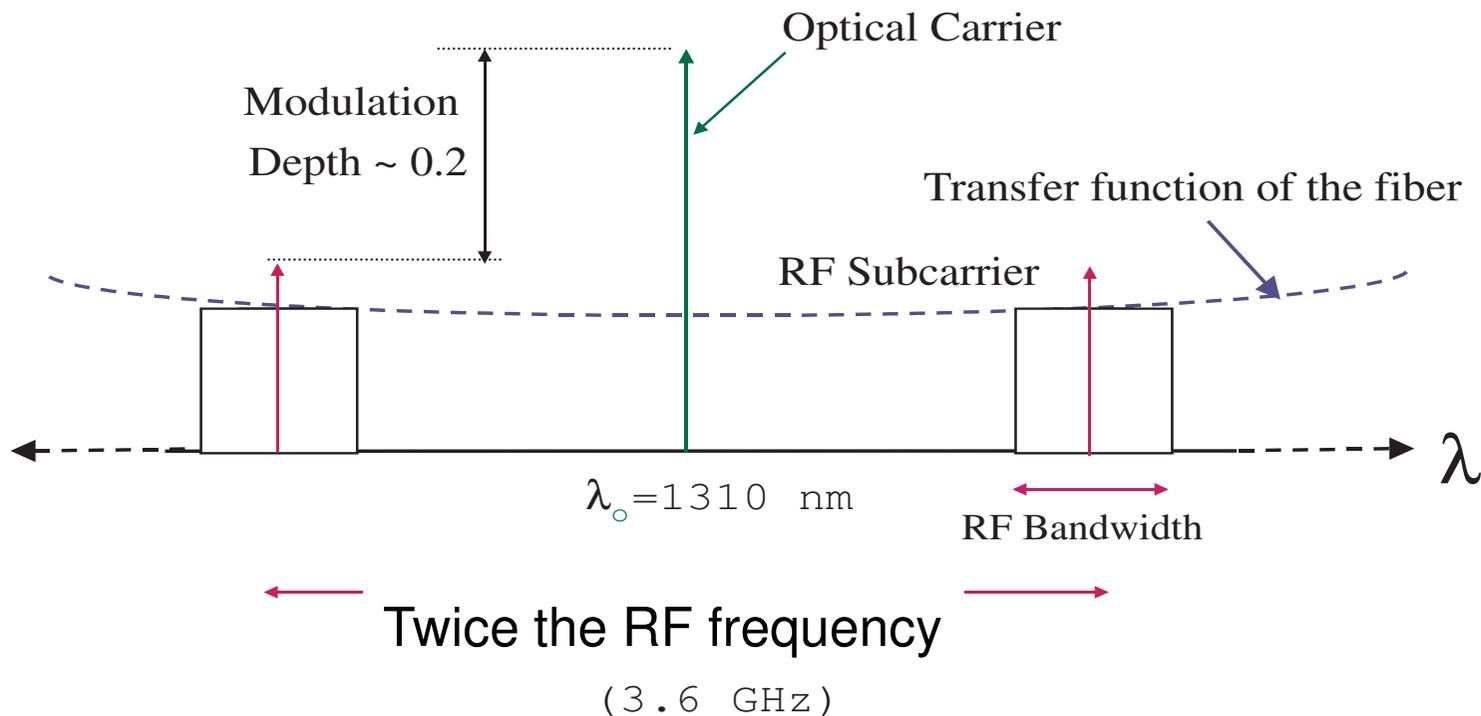

Two sidebands each separated by modulating frequency

# Limitations of Direct Modulation

- Turn on delay and resonance frequency are the two major factors that limit the speed of digital laser modulation
- Saturation and clipping introduces nonlinear distortion with analog modulation (especially in multi carrier systems)
- Nonlinear distortions introduce second and third order intermodulation products
- **Chirp**: Laser output wavelength drift with modulating current is also another issue, resulting in line broadening.

# Chirp

In laser diode, the refractive index varies with carrier density.

Modulation  $\rightarrow$  vary current  $\rightarrow$  vary carrier density  
 $\rightarrow$  vary refractive index  $\rightarrow$  index varies with time  
 $\rightarrow$  phase delay varies with time  $\rightarrow$  induces new frequency  
**frequency varies with time : chirp**

- chirp results in broadening of a laser linewidth
- chirp magnitude is  $\sim 100\text{MHz} - \text{GHz/mA}$ ,  
 $\sim 0.001\%$  of center frequency

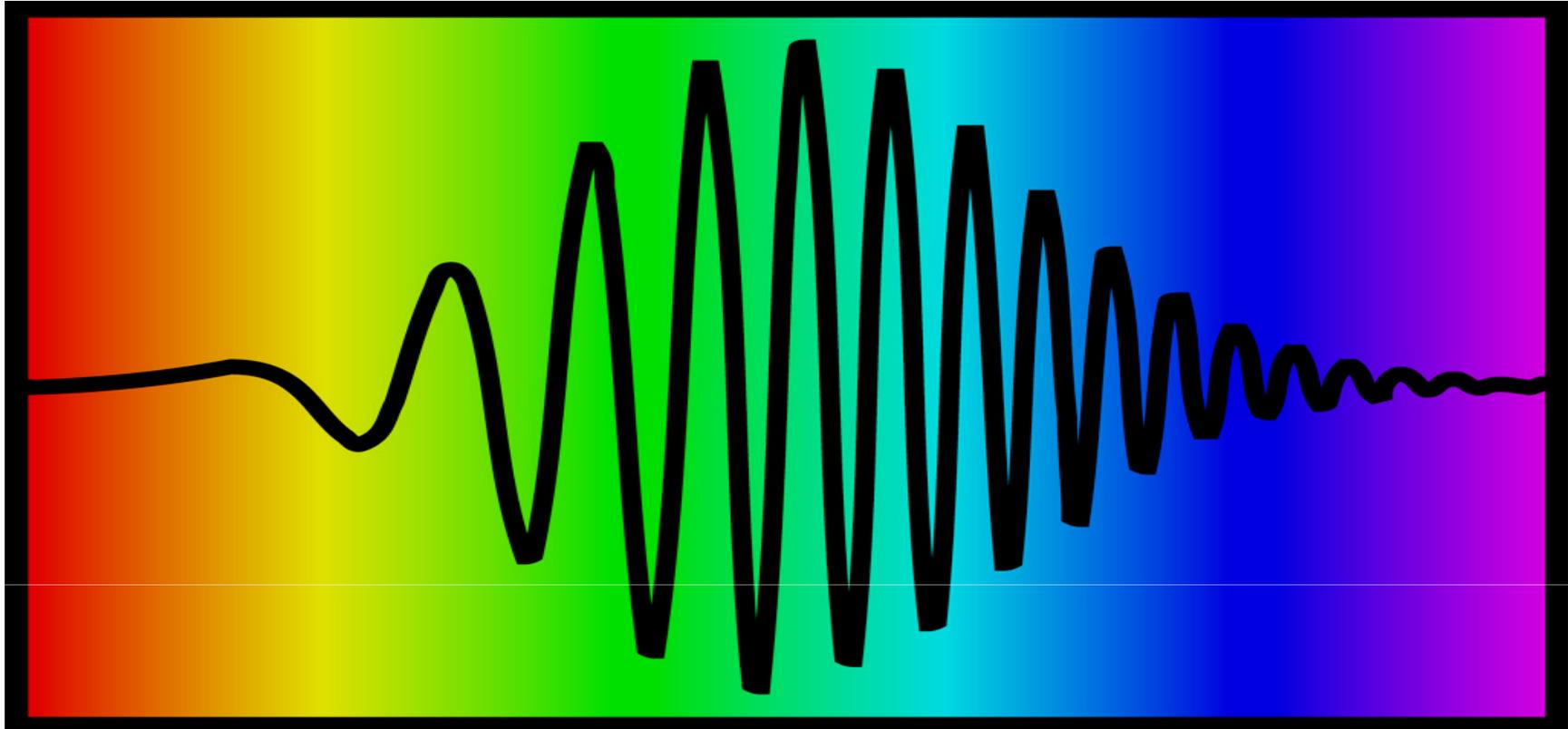

A pulse can have a frequency that varies in time.

This pulse increases its frequency linearly in time (from red to blue).

In analogy to bird sounds, this pulse is called a "chirped" pulse.

# Temperature variation of the threshold current

$$I_{th}(T) = I_z e^{T/T_0}$$

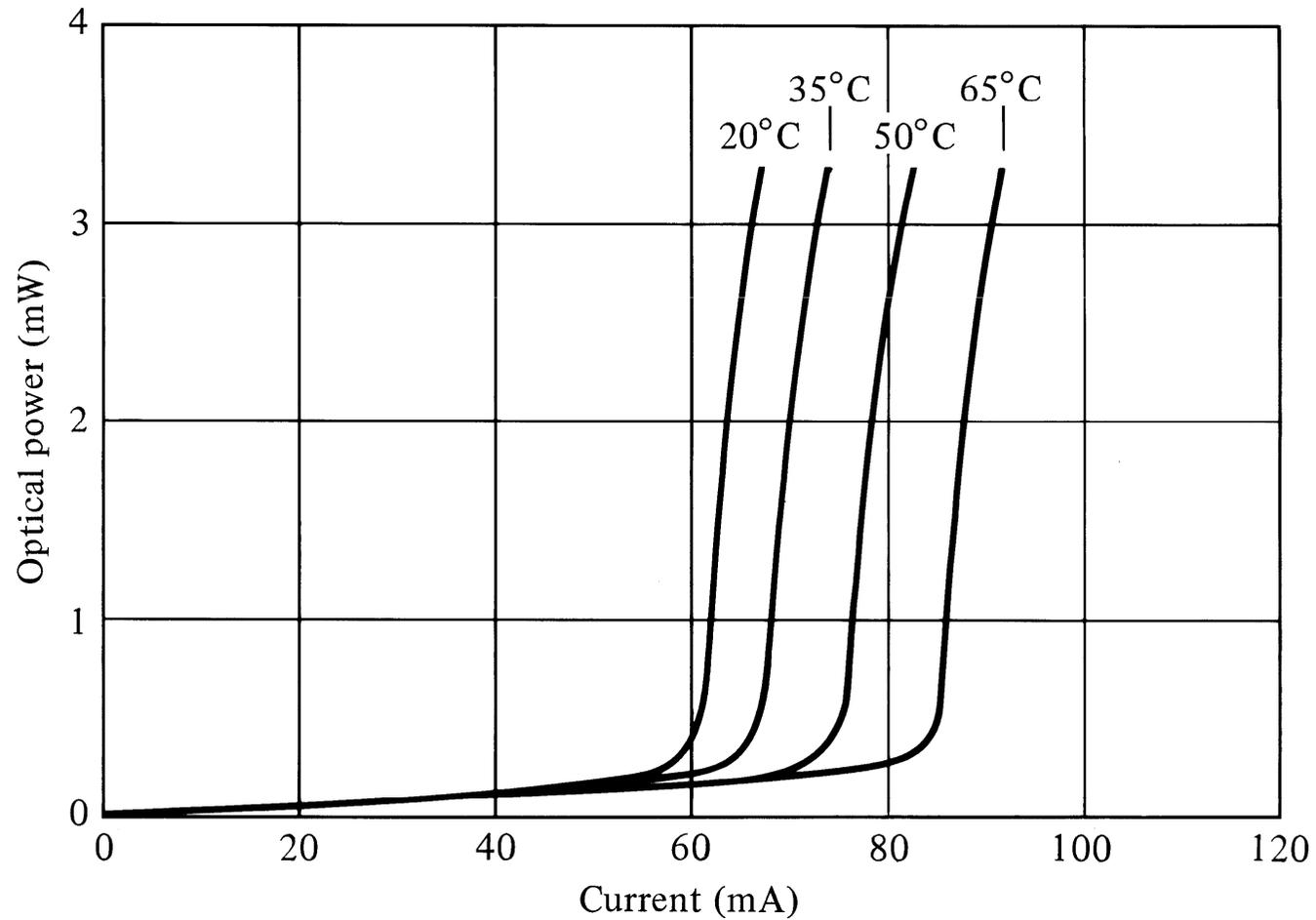

# External Optical Modulation

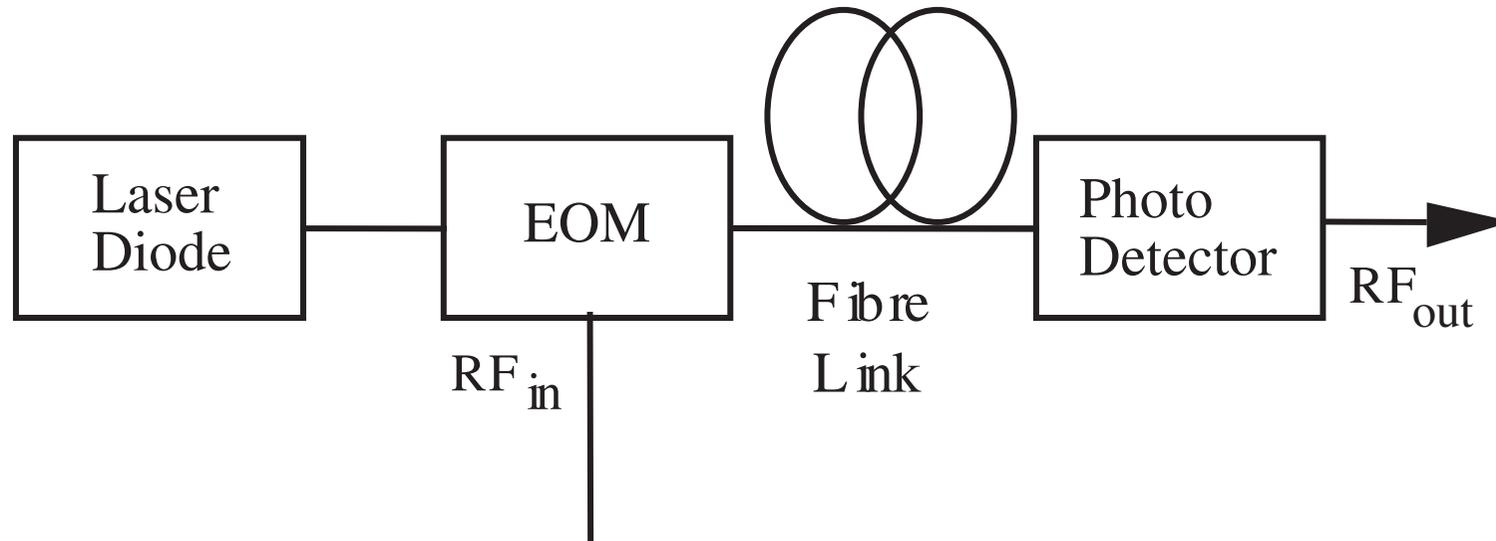

- Modulation and light generation are separated
- Offers much wider bandwidth → up to 60 GHz
- More expensive and complex
- Used in high end systems

# External Modulated Spectrum

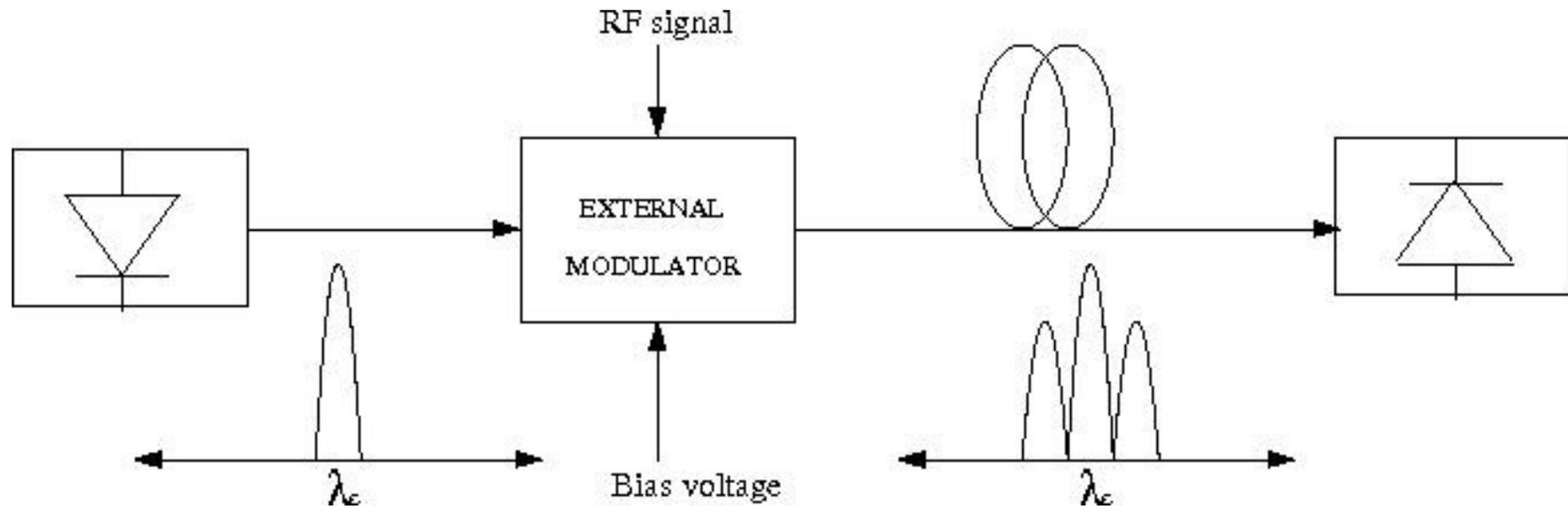

- Typical spectrum is double side band
- However, single side band is possible which is useful at extreme RF frequencies

# Mach-Zehnder Interferometers

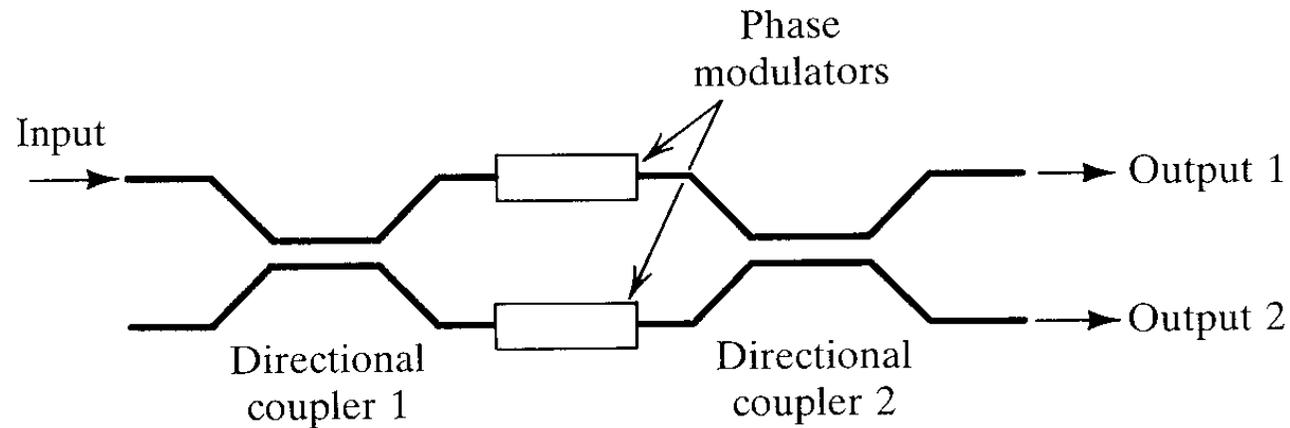

(a)

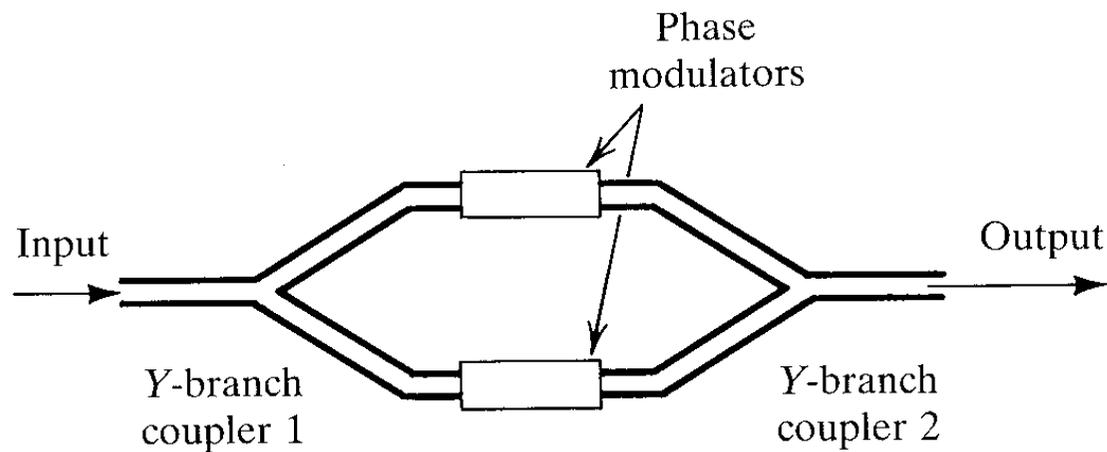

(b)

# Mach- Zehnder modulator

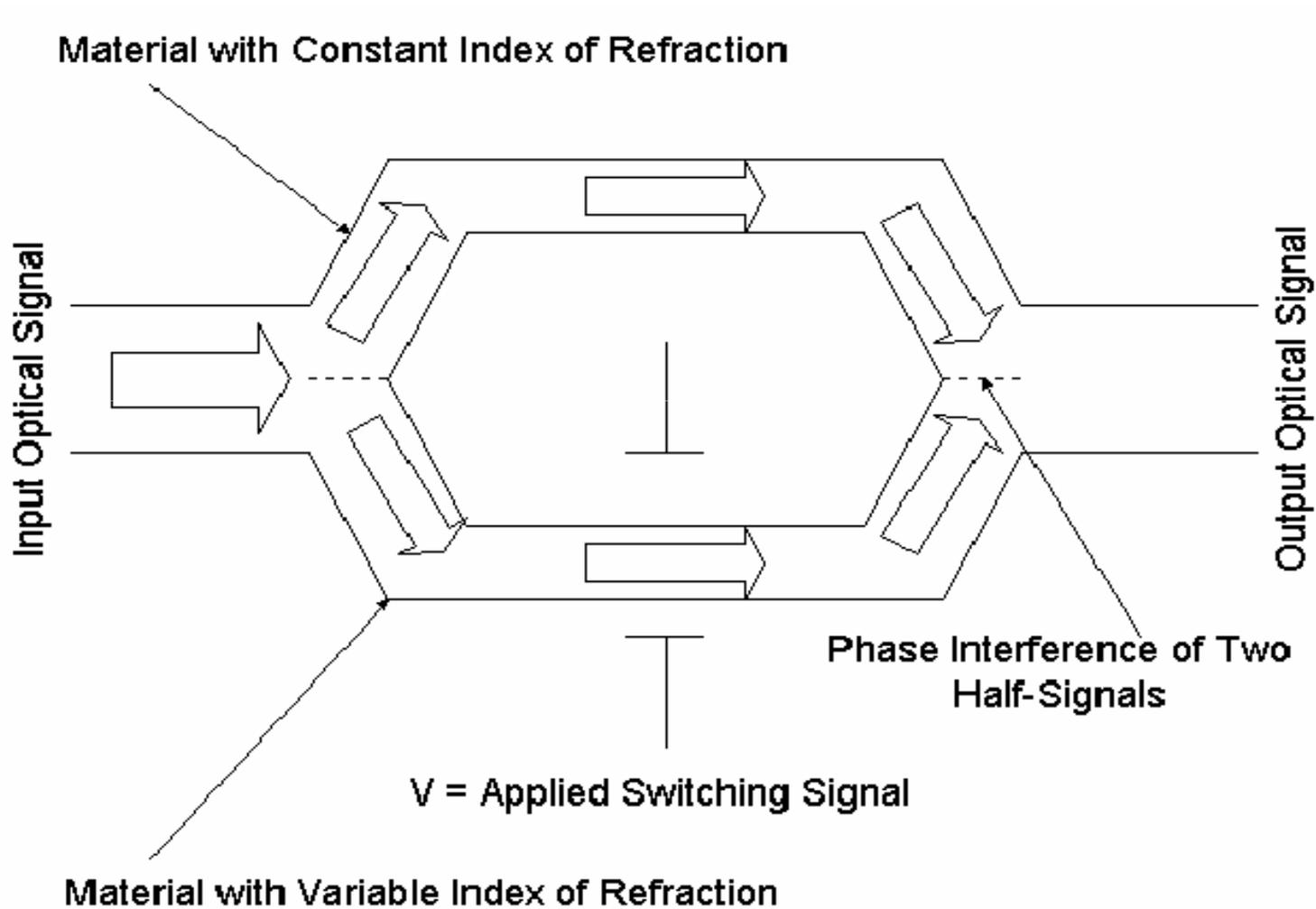

# Mach- Zehnder modulator

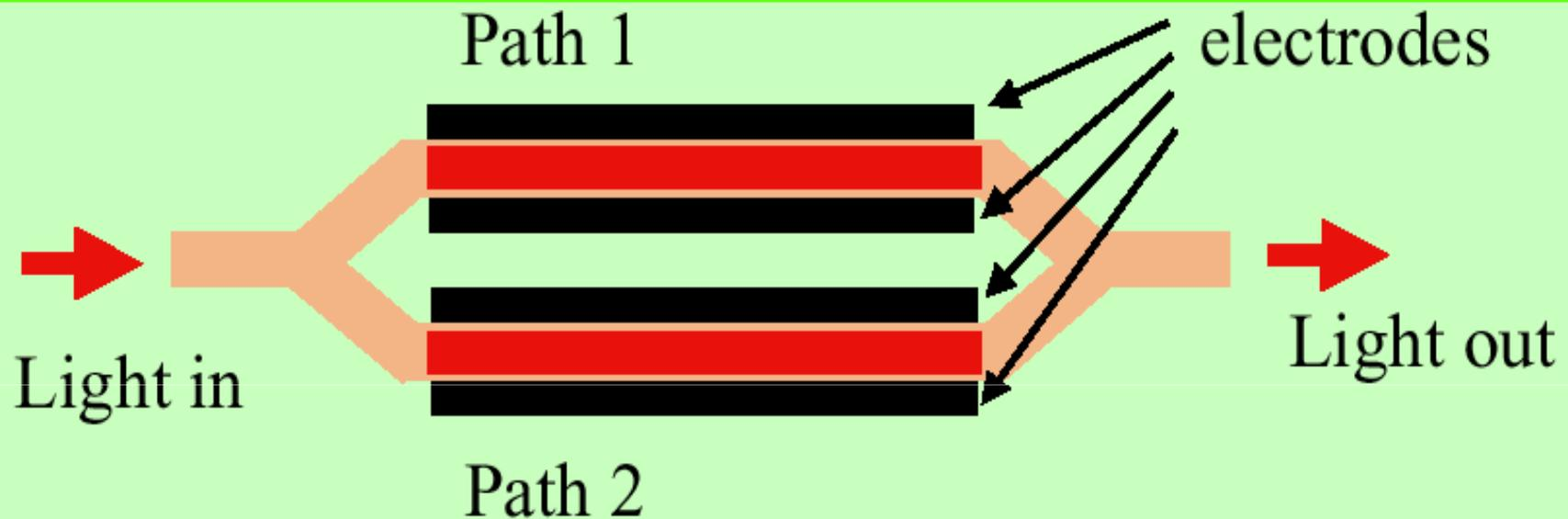

- Applying voltages to electrodes to change the refractive indices of light paths 1 & 2.
- The optical paths of 1 & 2 vary with the applied voltage.
- In phase → strong output light; out of phase → weak output.
- Output light is then modulated by voltage signal.

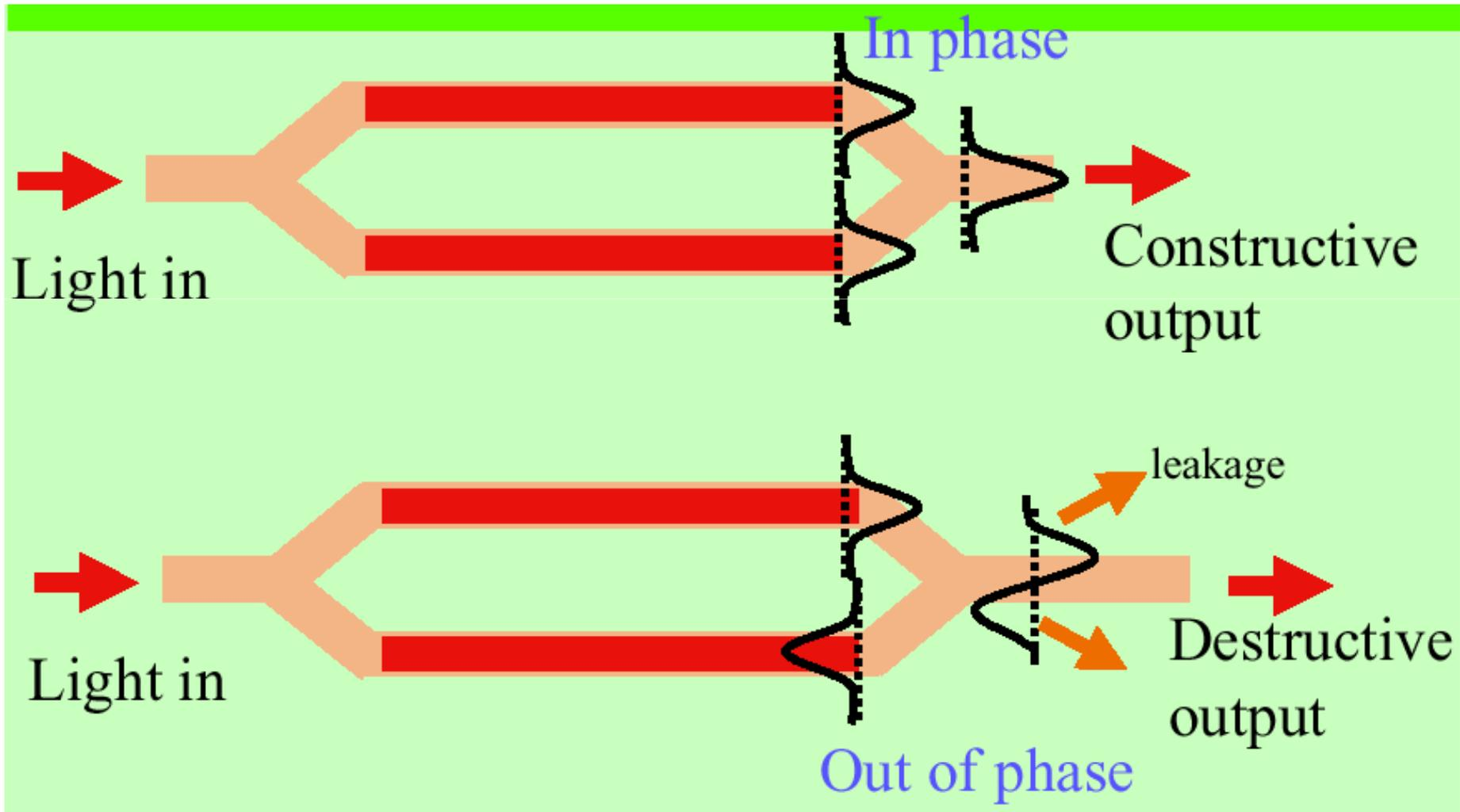

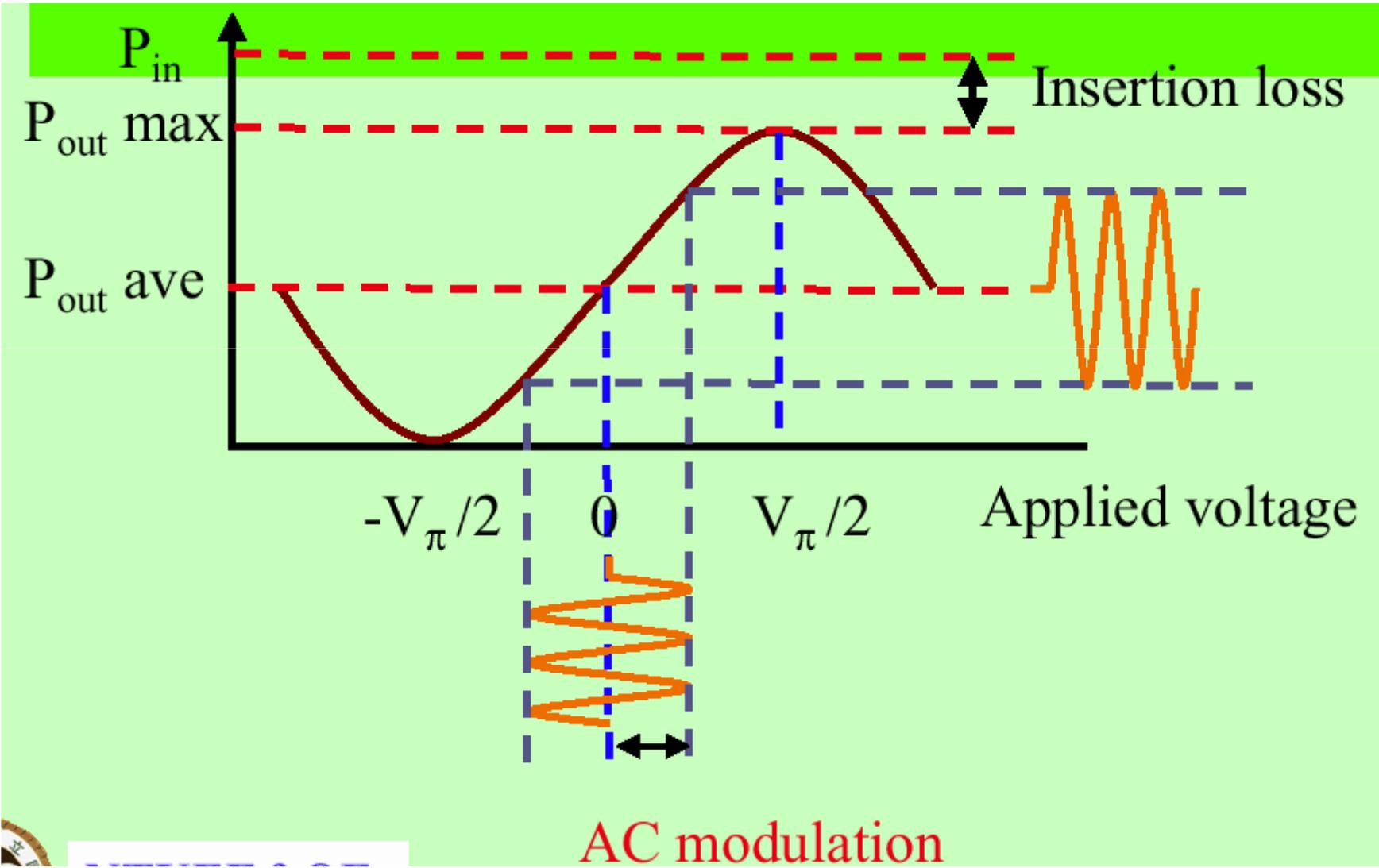

AC modulation

# Characteristics of Mach-Zehnder modulator

- material:  $\text{LiNbO}_3$
- modulation depth: better than 20 dB
- bandwidth : could be 60 GHz
- insertion loss :  $\geq 4$  dB
- power handling : 200 mW
- induced chirp : negligible
- $V_\pi$ : a few volts, depending on bandwidth

# Electro-absorption (EA) modulator

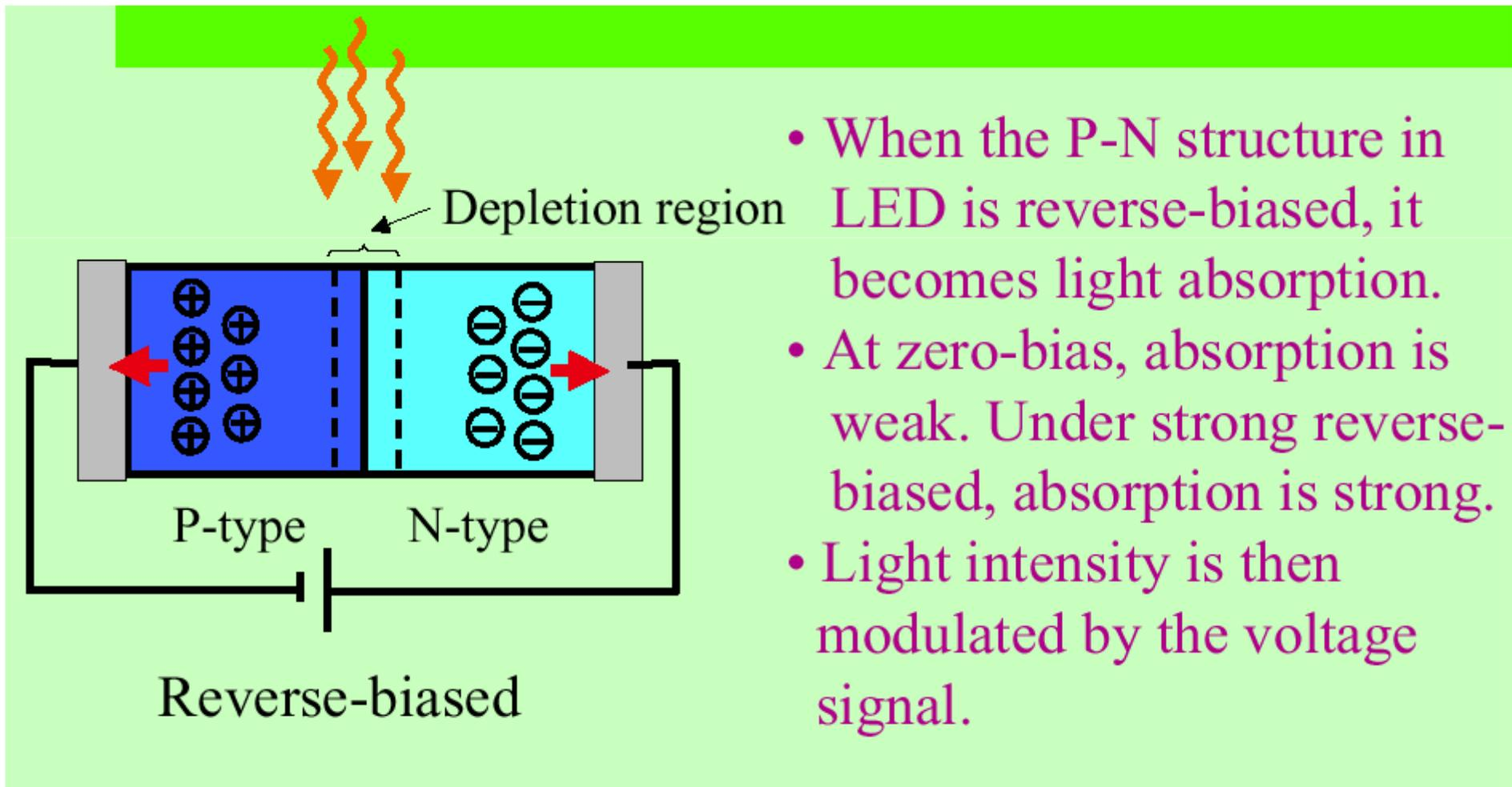

- When the P-N structure in LED is reverse-biased, it becomes light absorption.
- At zero-bias, absorption is weak. Under strong reverse-biased, absorption is strong.
- Light intensity is then modulated by the voltage signal.

# Integration of EA modulator with LD

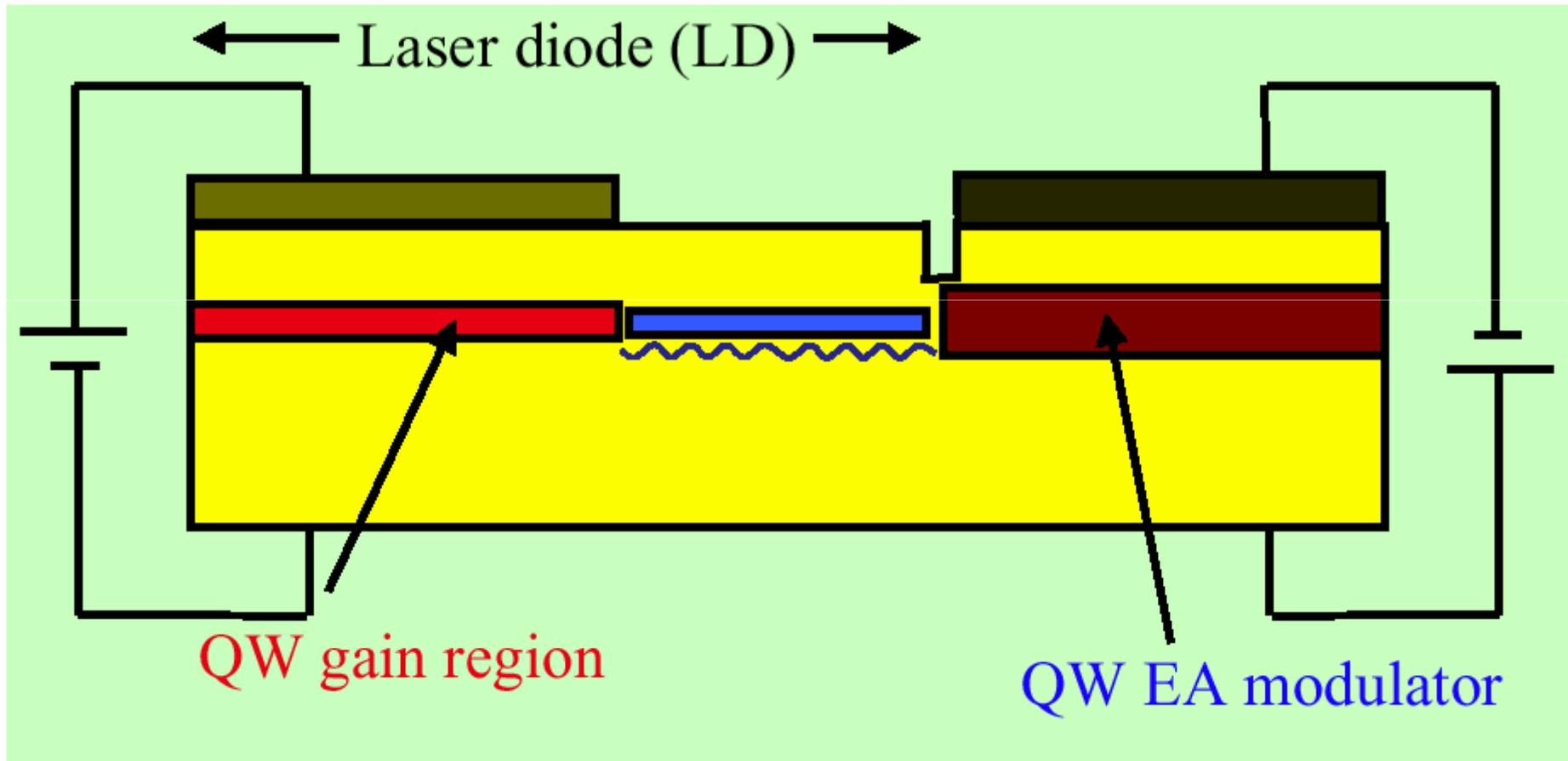

Quantum well (QW) Laser: laser diode whose active region is so narrow that quantum confinement occurs

# Characteristics of EA modulator

- material: semiconductor QWs
- modulation depth: better than 10 dB
- bandwidth : could be 40 GHz
- insertion loss : almost zero
- power handling : 1 mW
- induced chirp : negligible
- operation voltage: 2 V
- integrable with LD